

Last update: 03-2023

www.climate.emerson.com/en-gb

Ref: TI_PS1(2)_A1_A2L_A3_EN_Rev01

Application Engineering Europe

PRESSURE CONTROLS PS1 / PS2 SERIES

A1 A2L

General information

Adjustable Single and Dual Pressure Controls for high- and low-pressure applications.

Features

- Adjustable pressure range
- Narrow adjustable differential depending on model
- Range and differential pointer in units bar and psig
- Range and differential individually lockable by wire seal
- High rated SPDT contacts for all versions
- Chatter resistant contacts (bounce free)
- Heavy duty, finger-proof terminal blocks
- Captive terminal and cover screws
- Dual pressostats with two independent SPDT switches
- Manual toggle for system checkout and override
- Standard pressure connection 7/16"-20 UNF for 1/4" SAE male flare connection
- Low pressure and high-pressure versions available with TÜV approval acc. to EN 12263 to meet requirements of DIN 8901 and EN 378
- Automatic and manual reset versions
- Some versions with convertible auto/manual reset
- Locking plate and mounting screws included

Options

- Factory set to customer specification (minimum lot size 100 pieces)



PS1-W3U



PS2-A7A

Type code – PS1

PS 1 -

Product Name

PS1 Single standard version

PSA Customer specific version PS1

Function

A Pressure control, automatic reset

B Pressure cut out, external manual reset EN 12263

R Pressure control, external manual reset

S Safety pressure cut-out, internal manual reset EN 12263

U Convertible from R to A

W Pressure limiter, automatic, DIN / EN 12263

X Pressure control, automatic with extended adjustment spindles

Pressure Connector

A 7/16"-20 UNF male

C R 1/4" male, stainless steel with steel bellows

J 1 m capillary with 6 mm-ODM solder tube

K 1 m capillary with 7/16"-20 UNF flare nut and schrader valve opener

L 1 m capillary with 1/4"-ODM solder tube

R R 1/4" male, brass

U 6 mm ODF solder, 80 mm length

X 1/4"-ODF solder, 80 mm length

Pressure Range (bar)

	PS		PT		PS		PT	
1	-0.75...3	11	13	4	1...20	20	23	
2	-0.8...1.5	11	13	5	6...31	31	35	
3	-0.5...7	22	24					

NOTE: Function types B, R or S in combination with pressure range 1, 2 or 3 have a low-pressure manual reset function and latch with falling pressure. Function types B, R, S in combination with Pressure Range 4 or 5 have a high-pressure manual reset function and latch with rising pressure.

Type code – PS2

		PS 2	-	⏏	⏏	⏏
Product Name						
PS2 Dual Standard version						
PSB Customer specific version PS2						
Function						
A	both sides: Pressure control, automatic reset					
B	both sides: Pressure cut- out, external manual reset EN 12263					
C	left: Pressure limiter, automatic right: Pressure cut out, external manual reset, EN 12263					
G	left: Pressure cut out, external manual reset, right: Safety pressure cut-out, internal manual reset EN 12263					
L	left: Pressure control, automatic reset, right: Pressure control external manual reset					
M	left: Pressure control, autom. reset, right: Convertible from R to A					
N	left: Pressure control, autom. reset, right: Convertible from R to A, EN 12263					
R	both sides: Pressure control, external manual reset					
S	both sides: Safety pressure cut-out, internal man. reset EN 12263					
T	left: Pressure limiter, automatic right: Safety pressure cut- out, internal manual reset EN 12263					
U	both sides: Convertible from R to A					
W	both sides: Pressure limiter, automatic, DIN / EN 12263					
X	both sides: Pressure control, automatic with extended adjustment spindles					
Y	left: Pressure control, automatic reset right: Convertible from R to A; extended adjustment spindles					
Z	both sides: Convertible from R to A, extended adjustment spindles					
Pressure Connector						
A	7/16"-20 UNF male					
C	R 1/4" male, stainless steel with steel bellows					
J	1 m capillary with 6 mm-ODM solder tube					
K	1 m capillary with 7/16"-20 UNF flare nut and schrader valve opener					
L	1 m capillary with 1/4"-ODM solder tube					
U	6 mm ODF solder, 80 mm length					
X	1/4"-ODF solder, 80 mm length					
Pressure Range (bar)						
	<u>left</u>	<u>PS</u>	<u>PT</u>	<u>right</u>	<u>PS</u>	<u>PT</u>
7	-0.5...7	22	24	6...31	31	35
8	6...31	31	35	6...31	31	35
9	-0.75...3	11	13	6...31	31	35

Selection Table – Single Pressure Controls PS1

Type	Part No.	Adjustment Range		Lowest Setpoint (bar)	Factory Setting (bar)	Leakage Test Pressure (bar)	Pressure Connection
		Upper Setpoint (bar)	Differential Setpoint (bar)				
Low Pressure Controls							
PS1-A3A	4370700	-0.5...7	0.5...5	-0.9	3.5 / 4.5	24	7/16"-20 UNF
PS1-A3K	4370600	-0.5...7	0.5...5	-0.9	3.5 / 4.5	24	capillary/ nut
PS1-A3L	4714945	-0.5...7	0.5...5	-0.9	3.5 / 4.5	24	cap./ solder tube 1/4"
PS1-A3U	4712201	-0.5...7	0.5...5	-0.9	3.5 / 4.5	24	solder 6 mm
PS1-A3X	4713430	-0.5...7	0.5...5	-0.9	3.5 / 4.5	24	solder tube 1/4"
PS1-R3A	4350100	-0.5...7	Ext. man. reset approx. 1 bar above setpoint	-0.9	3.5	24	7/16"-20 UNF
PS1-R3K	4713431	-0.5...7		-0.9	3.5	24	capillary/ nut
High Pressure Controls							
PS1-A5A	4350500	6...31	2...15	3	16 / 20	35	7/16"-20 UNF
PS1-A5K	4370400	6...31	2...15	3	16 / 20	35	capillary/ nut
PS1-A5L	4715136	6...31	2...15	3	16 / 20	35	cap./solder tube 1/4"
PS1-A5U	4713325	6...31	2...15	3	16 / 20	35	solder 6 mm
PS1-A5X	4713434	6...31	2...15	3	16 / 20	35	solder tube 1/4"
PS1-R5A	4350700	6...31	Ext. man. reset approx. 3 bar below setpoint	-	20	35	7/16"-20 UNF
PS1-R5K	4370300	6...31		-	20	35	capillary/ nut

NOTE: For assistance with selection, please contact your local Emerson Sales offices.

Selection Table – Single Pressure Controls PS1 (EN 12263)

Type	Part No.	Adjustment Range		Lowest Setpoint (bar)	Factory Setting (bar)	Leakage Test Pressure (bar)	Pressure Connection
		Upper Setpoint (bar)	Differential Setpoint (bar)				

Pressure Limiter for low pressure protection EN 12263 PSL (automatic reset)

PS1-W3A	4368300	-0.5...7	0.5...5	-0.9	3.5 / 4.5	24	7/16"-20 UNF
PS1-W3U	4713437	-0.5...7	0.5...5	-0.9	3.5 / 4.5	24	solder 6 mm

Pressure Cut Out for low pressure protection EN 12263 PZL (external manual reset)

PS1-B3A	4470400	-0.5...7	Ext. man. reset approx. 1 bar above setpoint	-0.9	3.5	24	7/16"-20 UNF
PS1-B3U	4715141	-0.5...7		-0.9	3.5	24	solder 6 mm

Pressure Limiter for high pressure protection EN 12263 PSH (automatic reset)

PS1-W5A	4353200	6...31	2...15	3	16 / 20	35	7/16"-20 UNF
PS1-W5K	4359100	6...31	2...15	3	16 / 20	35	capillary/ nut
PS1-W5U	4713439	6...31	2...15	3	16 / 20	35	solder 6 mm

Pressure Cut Out for high pressure protection EN 12263 PZH (external manual reset)

PS1-B5A	4353300	6...31	Ext. man. reset approx. 3 bar below setpoint	-	20	35	7/16"-20 UNF
PS1-B5J	4715758	6...31		-	20	35	cap./ solder 6 mm
PS1-B5U	4712332	6...31		-	20	35	solder 6 mm

Safety Pressure Cut Out for high pressure protection EN 12263 PZHH (internal manual reset)

PS1-S5A	4368400	6...31	Int. man. reset approx. 3 bar below setpoint	-	21	35	7/16"-20 UNF
PS1-S5U	4711591	6...31		-	21	35	solder 6 mm

NOTE: For assistance with selection, please contact your local Emerson Sales offices.

Selection Table - Dual Pressure Controls PS2

Type	Part No.	Adjustment Range				Factory Setting (bar)		Leakage Test Pressure (bar)		Pressure Connection
		Upper Setpoint (bar)		Differential Setpoint (bar)		left	right	left	right	
		left	right	left	right					

Combined Low and High Pressure Controls

PS2-A7A	4353400	-0.5...7	6...31	0.5 ¹ ...5	~ 4 fix	3.5 / 4.5	20	24	35	7/16"-20 UNF
PS2-A7K	4350900	-0.5...7	6...31	0.5 ¹ ...5	~ 4 fix	3.5 / 4.5	20	24	35	capillary/ nut
PS2-A7L	4713565	-0.5...7	6...31	0.5 ¹ ...5	~ 4 fix	3.5 / 4.5	20	24	35	cap./ solder ¼"
PS2-A7U	4713415	-0.5...7	6...31	0.5 ¹ ...5	~ 4 fix	3.5 / 4.5	20	24	35	solder 6 mm
PS2-A7X	4713416	-0.5...7	6...31	0.5 ¹ ...5	~ 4 fix	3.5 / 4.5	20	24	35	solder tube ¼ "
PS2-L7A	4351100	-0.5...7	6...31	0.5 ¹ ...5	~ 4 fix	3.5 / 4.5	20	24	35	7/16"-20 UNF
PS2-L7K	4370500	-0.5...7	6...31	0.5 ¹ ...5	Ext. man. reset approx. 4 bar below setpoint	3.5 / 4.5	20	24	35	Capillary/ nut
PS2-L7U	4713417	-0.5...7	6...31	0.5 ¹ ...5		3.5 / 4.5	20	24	35	solder 6 mm
PS2-R7A	4351300	-0.5...7	6...31	0.5 ¹ ...5		3.5 / 4.5	20	24	35	7/16"-20 UNF
PS2-R7K	4713421	-0.5...7	6...31	Ext. man. reset approx. 1 bar above setpoint	Ext. man. reset approx. 4 bar below setpoint	3.5	20	24	35	Capillary/ nut
PS2-R7U	4713419	-0.5...7	6...31			3.5	20	24	35	solder 6 mm

NOTE: For assistance with selection, please contact your local Emerson Sales offices.

¹) lowest possible setpoint: -0.9 bar

Selection Table – Dual Pressure Controls PS2 (EN 12263)

Type	Part No.	Adjustment Range				Factory Setting		Leakage Test Pressure		Pressure Connection
		Upper Setpoint (bar)		Differential Setpoint (bar)		(bar)		(bar)		
		left	right	left	right	left	right	left	right	

**Combined Pressure Limiter for low pressure / high pressure protection
EN 12263; PSL / PSH (automatic / automatic)**

PS2-W7A	4360100	-0.5...7	6...31	0.5 ¹ ...5	~ 4 fix	3.5 / 4.5	20	24	35	7/16"-20 UNF
PS2-W7L	4450300	-0.5...7	6...31	0.5 ¹ ...5	~ 4 fix	3.5 / 4.5	20	24	35	cap./ solder ¼"
PS2-W7U	4712436	-0.5...7	6...31	0.5 ¹ ...5	~ 4 fix	3.5 / 4.5	20	24	35	solder 6 mm

**Combined Pressure Limiter / Pressure Cut Out for low pressure / high pressure protection
EN 12263; PSL / PZH (automatic / external manual reset)**

PS2-C7A	4353500	-0.5...7	6...31	0.5 ¹ ...5	Ext. man. reset approx. 4 bar below setpoint	3.5 / 4.5	20	24	35	7/16"-20 UNF
PS2-C7L	4715131	-0.5...7	6...31	0.5 ¹ ...5		3.5 / 4.5	20	24	35	cap./ solder ¼"

Combined Low and High Pressure Controls. High side convertible from automatic to manual reset

PS2-M7A	4361300	-0.5...7	6...31	0.5 ¹ ...5	-	3.5 / 4.5	21	24	35	7/16"-20 UNF
---------	---------	----------	--------	-----------------------	---	-----------	----	----	----	--------------

**Combined Pressure Limiter Safety Pressure Cut Out for low pressure / high pressure protection
EN 12263, PSL / PZH (automatic / automatic convertible to external manual reset)**

PS2-N7A	4715756	-0.5...7	6...31	0.5 ¹ ...5	-	3.5 / 4.5	21	24	35	7/16"-20 UNF
---------	---------	----------	--------	-----------------------	---	-----------	----	----	----	--------------

**Combined Pressure Limiter / Safety Pressure Cut Out for low pressure / high pressure protection
EN 12263 PSL / PZHH (automatic / internal manual reset)**

PS2-T7A	4368500	-0.5...7	6...31	0.5 ¹ ...5	Int. man. reset approx. 4 bar below setpoint	3.5 / 4.5	21	24	35	7/16"-20 UNF
PS2-T7U	4713424	-0.5...7	6...31	0.5 ¹ ...5		3.5 / 4.5	21	24	35	solder 6 mm

**Combined Pressure Cut Out for low pressure / high pressure protection
EN 12263, PZL / PZH (external manual reset / external manual reset)**

PS2-B7A	4360200	-0.5...7	6...31	Ext. man. reset approx. 1 bar above setpoint	Ext. man. reset approx. 4 bar below setpoint	3.5	20	24	35	7/16"-20 UNF
PS2-B7K	4446600	-0.5...7	6...31			3.5	20	24	35	capillary/ nut
PS2-B7L	4446700	-0.5...7	6...31			3.5	20	24	35	cap./solder ¼"
PS2-B7U	4449400	-0.5...7	6...31			3.5	20	24	35	solder 6 mm

**Combined Pressure Cut Out / Safety Pressure Cut Out for high pressure / high pressure protection
EN 12263, PZH / PZHH (external manual reset / internal manual reset)**

PS2-G8A	4368600	6...31	6...31	Ext. man. reset approx. 4 bar below setpoint	Int. man. reset approx. 4 bar below setpoint	20	21	35	35	7/16"-20 UNF
PS2-G8U	4713427	6...31	6...31			20	21	35	35	solder 6 mm
PS2-G8X	4713428	6...31	6...31			20	21	35	35	solder tube ¼"

NOTE: For assistance with selection, please contact your local Emerson Sales offices.

¹⁾ lowest possible setpoint: -0.9 bar

Selection Table Accessories

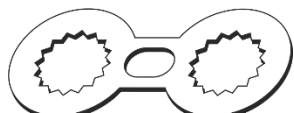
Type	Part No.	Description	Illustration
Mounting bracket angle	803799	incl. screws	See Dimensions
Mounting plate for units with hood	803801	incl. screws	See Dimensions
Extension bracket	803800	incl. screws	See Dimensions
Universal mounting bracket	803798	incl. screws	See Dimensions
Locking plate	803783	incl. 2 mounting screws, 20 pcs	

General Hints

High pressure limiters and pressure cut outs with type approval according to EN 12263 feature a double bellows design.

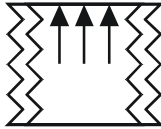

Should the inner bellows leak, then the larger surface area of the outer bellows creates a larger force and causes the pressostat to a pre-empted cut out. This represents a fail-safe function.

Electrical contacts

PS1/2 pressure controls are equipped with high rated double snap action contacts for shatter-free and reliable operation. All contacts are designed as Single Pole Double Throw (SPDT) contacts. Dual pressostats PS2 come with two independently actuated SPDT contacts.

Switch Points

The set points are adjustable with internal adjustment spindles. The range spindle allows pre-setting the *upper switch point* together with the *lower switch point*. The differential spindle is used to pre-set the *lower switch point*. The dependency between upper and lower set point is as follows:

$$\text{lower set point} = \text{upper set point} - \text{differential}$$

Devices with manual reset feature have a fixed differential. Manual reset is possible as soon as pressure falls below / rises above this fixed differential (see selection table).

Contact function

Contacts on Single Pressostats PS1 are labelled 1-2-4, contacts on Dual Pressostats are labelled 11-12-14 on the left side and 21-22-24 on the right side. '1', '11', '21' refer to the common pole. '2', '12', '22' refer to the lower setpoint and '4', '14', '24' refer to the upper setpoint. This is true for all functions: low pressure controls, high pressure controls, manual or automatic reset types.

Automatic reset

On pressure rise above the upper setpoint, contacts 1-2 (11-12; 21-22) open and contacts 1-4 (11-14, 21-24) close. On decreasing pressure below lower setpoint contacts 1-4 (11-14; 21-24) open and contacts 1-2 (11-12; 21-22) close.

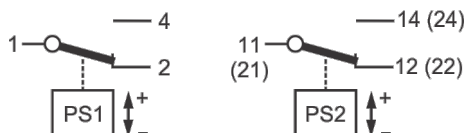

Manual reset low pressure

On decreasing pressure below the lower setpoint, contacts 1-4 open, contacts 1-2 close and latch. On pressure rise above fixed differential per Selection Table and after pressing the manual reset button, contacts 1-2 will open and contacts 1-4 will close again.

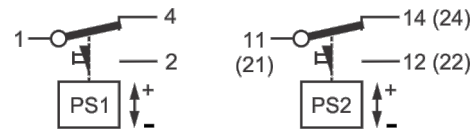

Manual reset high pressure

On increasing pressure above the upper setpoint, contacts 1-2 open, contacts 1-4 close and latch. On falling pressure below fixed differential per Selection Table and after pressing the manual reset button, contacts 1-4 will open and contacts 1-2 will close again.

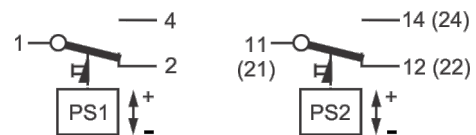

For operational safety, all PS1/2 with manual reset are designed as *trip-free* controls, i.e. pressing the manual reset button while the pressure has not reached its reset threshold will not operate the electrical contacts.

Installation and maintenance

A front access manual toggle is provided for checking out control operation. On low pressure controls this toggle may be used to override the low-pressure signal during system evacuation, avoiding the need to undo the electrical wiring for this purpose.

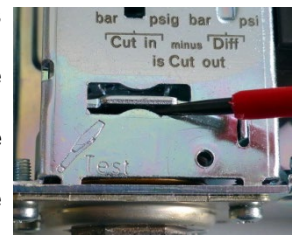

The standard mounting holes for mounting brackets are equipped with a universal thread to fit both, M4 and UNC 8-32 screws.

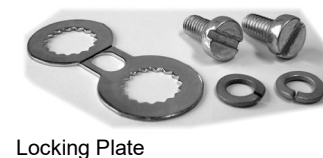





Locking Plate

The standard wholesale package includes two mounting screws. Several hole patterns for surface mounting are provided, see "Dimensions" on page 7.

Technical Data

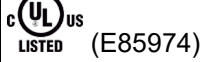
Temperatures Storage/ Ambient/ Transport / Medium	-50 °C...+70 °C	
Housing materials cover frame	Polycarbonate (PC) Steel (with anti corrosion protection)	
Materials Pressure Connections with medium contact (A) / bellows (K, L, U, X) / bellows	brass / bronze copper / bronze	
Released Refrigerants Fluid group II Fluid group I	R448A, R449A, R513A, R450A, R134a, R452A, R23, R410A, R407C, R404A, R507, R124, R1234ze (A2L)	(A1)
	R32, R452B, R454B, R454A, R454C, R455A, R1234yf	(A2L)

Protection Class (EN 60529)	IP44 Control mounted flush against wall
Vibration Resistance (EN 12263)	4 g (10...1000 Hz)
Standards specific models all types all types with EN 12263 (TÜV)	EN 12263 (TÜV) LVD PED 2014/68/EU
Markings for devices under PED for devices under LVD all types all types all types	
	
	
	

Electrical Data

Type of contacts		PS1 PS2	1 x SPDT contact 2 x SPDT contacts
(A1)	Resistive load (AC1)	24 A / 230 VAC	
	Inductive load (AC15)	10 A / 230 VAC	
	Inductive load (DC13)	0.1 A / 230 VDC 3 A / 24 VDC 6 A / 12 VDC	
	Startup / Locked Rotor (AC3)	144 A / 120 VAC / 230 VAC	
	Motor rating UL (FLA)	24 A / 120 VAC / 240 VAC	
	Locked rotor (LRA)	144 A / 120 VAC / 240 VAC	

Contact material standard		CuAg3
(A2L)	Resistive load (AC1)	10 A / 230 VAC*
	Inductive load (AC15)	1 A / 230 VAC* 10 A / 24 VAC*
	Inductive load (DC13)	0.1 A / 230 VDC* 3 A / 24 VDC* 6 A / 12 VDC*
	Startup / Locked Rotor (AC3)	-
	Motor rating UL (FLA)	-
	Locked rotor (LRA)	-

NOTE: *) acc. IEC 60335-2-40 max. electrical load = 2.5 kVA

Dimension (mm)

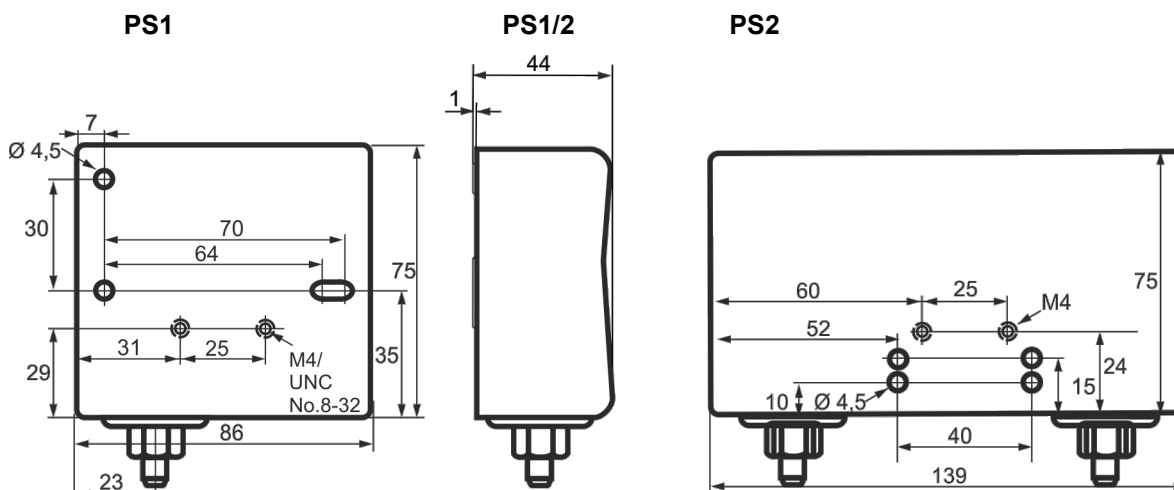

Dimension (mm)

Pressure Connections

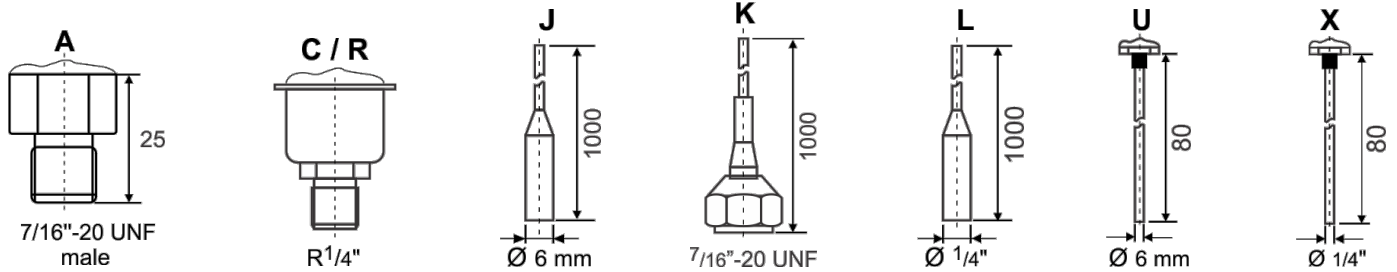

Accessories

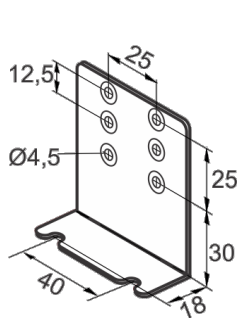

Mounting bracket angle

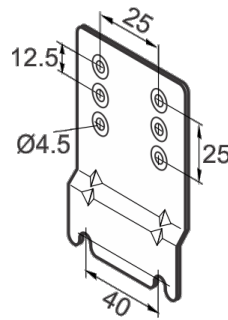

Mounting plate for units with hood

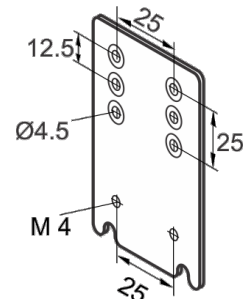

Extension bracket

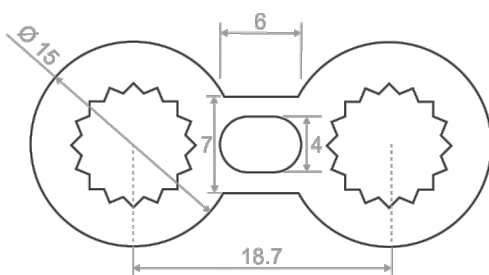

Locking plate

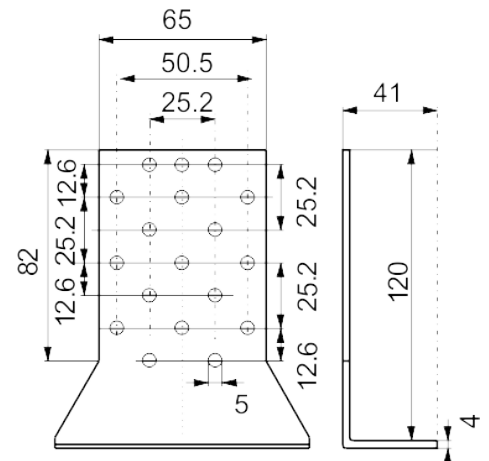

Univ. mounting bracket

DISCLAIMER

1. The contents of this publication are presented for informational purposes only and are not to be construed as warranties or guarantees, express or implied, regarding the products or services described herein or their use or applicability.
2. Emerson Climate Technologies GmbH and/or its affiliates (collectively "Emerson"), as applicable, reserve the right to modify the design or specifications of such products at any time without notice.
3. Emerson does not assume responsibility for the selection, use or maintenance of any product. Responsibility for proper selection, use and maintenance of any Emerson product remains solely with the purchaser or end user.
4. Emerson does not assume responsibility for possible typographic errors contained in this publication.