

MRLDS-450 Refrigerant Gas Detection Installation and Operation Manual



026-1316 Rev 2





Emerson Commercial & Residential Solutions
1065 Big Shanty Road NW, Suite 100
Kennesaw, GA 30144 USA
770-425-2724 • www.emerson.com
Email: ColdChain.TechnicalServices@Emerson.com

CONTENTS

1 INTRODUCTION	1
1.1. ABOUT THIS MANUAL.....	1
1.2. ICONOGRAPHY	1
1.3. GENERAL SAFETY REQUIREMENTS.....	2
1.4. SAFE CONNECTION OF ELECTRICAL DEVICES	3
2 PRODUCT DESCRIPTION	4
2.1. INTENDED USES/APPLICATIONS.....	4
2.2. MRLDS-450.....	4
2.2.1. MRLDS-450 Product Overview.....	4
2.2.2. MRLDS-450 Design Features	5
2.2.3. MRLDS-450 Component Overview	6
3 INSTALLATION	7
3.1. GENERAL INFORMATION.....	7
3.2. RESTRICTIONS.....	8
3.3. MECHANICAL INSTALLATION	8
3.4. ELECTRICAL INSTALLATION	8
3.4.1. Preparations.....	8
3.4.2. Power and Signal Wiring.....	9
3.4.3. Relay Wiring.....	10
3.4.4. Modbus RTU RS-485 Interface	10
3.4.5. Conclusion.....	13
3.5. SET UP MRLDS-450 APPLICATION IN E2.....	14
3.5.1. New Installation: Uploading the MRLDS-450 Description File to E2.....	14
4 OPERATION	23
4.1. OVERVIEW OF NORMAL OPERATION	23
4.1.1. Applying Power and the Start-up Sequence.....	23
4.1.2. Verifying Analog Signals.....	23
4.1.3. Verifying the Modbus Signal	24
4.1.4. Status Indication.....	24
4.1.5. Switch Functions	25
4.1.6. Reset System to Factory Default Settings.....	27
4.2. MRLDS-400 SERIES APPLICATION	27
4.2.1. Enable Bluetooth® Connection.....	27
4.2.2. Checking Status	28
4.2.3. Instrument Configuration	29
5 CARE AND MAINTENANCE	36
5.1. MAINTENANCE INTERVALS	36
5.2. ADJUSTMENTS.....	37
5.2.1. Introduction	37
5.2.2. General Calibration Procedure	37

5.2.3. <i>Zero Adjustment</i>	38
5.2.4. <i>Span Adjustment</i>	39
5.2.5. <i>System Bump Test</i>	40
5.3. TROUBLESHOOTING	41
5.3.1. <i>Hexadecimal Format</i>	41
5.3.2. <i>Fault Codes</i>	41
5.4. SENSOR MAINTENANCE.....	44
5.4.1. <i>Replacing Sensor Module</i>	45
5.5. CLEANING THE INSTRUMENT.....	46
6 ADDITIONAL INFORMATION.....	47
6.1. SENSOR PRINCIPLE	47
6.1.1. <i>Electrochemical Sensors</i>	47
6.1.2. <i>Catalytic Bead Sensors</i>	47
6.1.3. <i>Semiconductor Sensors</i>	48
6.1.4. <i>Infrared Sensors</i>	48
6.2. DISPOSING OF THE INSTRUMENT	49
6.2.1. <i>Disposing of the Electrical and Electronic Equipment</i>	49
6.2.2. <i>Disposing of Sensors</i>	49
6.3. TECHNICAL SPECIFICATIONS	50
6.3.1. <i>General Specifications</i>	50
7 ORDERING INFORMATION.....	51

1 Introduction

1.1. About this Manual

Thank you for investing in an MRLDS-450 Gas Detector. To ensure operator safety and the proper use of the gas detector, please read the contents of this manual for important information about the operation and maintenance of the instrument.



IMPORTANT: Before installing this product, carefully read and strictly follow the instructions in the manual.

1.2. Iconography





Alert	Icon	Description
<i>Danger</i>		<i>Imminently hazardous situation which, if not avoided, will result in serious injury or death.</i>
<i>Warning</i>		<i>Potentially hazardous situation which, if not avoided, could result in serious injury or death. Potential electrical shock hazard which, if not avoided, could result in serious injury or death.</i>
<i>Caution</i>		<i>Potentially hazardous situation which, if not avoided, could result in physical injury or damage to the product or environment. It may also be used to alert against unsafe practices.</i>
<i>Important</i>		<i>Additional information on how to use the product.</i>

Table 1-1 - Icons

1.3. General Safety Requirements



IMPORTANT: Before using this product, carefully read and strictly follow the instructions in the manual. Ensure that all product documentation is retained and available to anyone operating the instrument.



DANGER! This instrument is neither certified nor approved for operation in oxygen-enriched atmospheres. Failure to comply may result in personal injury or death.



DANGER! This instrument has not been designed to be intrinsically safe for use in areas classified as being hazardous locations. For your safety, **DO NOT** use it in hazardous (classified) locations.



WARNING! Use this product only for the purposes specified in this document and under the conditions listed.



CAUTION! In the event of an alarm or over-range condition, the sensor must be re-calibrated to ensure continued accuracy.



CAUTION! This product must be re-calibrated if installed in a non-room condition environment (For example, temperature or humidity extremes).



CAUTION! The gas diffusion path can become occluded (moisture, dust, debris, frozen condensation) over time resulting in reduced or complete lack of gas detection and alarming function. Routine visual inspection of the gas detector and bump testing are suggested to ensure proper gas detection and alarm function.



CAUTION! Except for maintenance detailed in this manual, these products should only be opened and/or serviced by authorized Emerson Technical Support personnel. Failure to comply may void the warranty.



CAUTION! Operator assumes responsibility for complying with all laws, rules and regulations governing the use of this product.



CAUTION! Use only genuine Emerson parts and accessories. Failure to comply may impair the operation of the product and/or void the warranty.



CAUTION! Only operate the product within the framework of a risk-based alarm signaling concepts.



WARNING! The gas diffusion path can become occluded (moisture, dust, debris, frozen condensation) over time, resulting in reduced or complete lack of gas detection and alarming function. Routine visual inspection of the gas detector and bump testing are recommended to ensure proper gas detection and alarm function. For information on calibrating the sensor, refer to the “Care and Maintenance” section of this manual.

1.4. Safe Connection of Electrical Devices



WARNING! Before connecting this instrument to electrical devices not mentioned in this manual, consult the manufacturer or a qualified professional. Failure to comply may result in personal injury and/or damage to the product.

2 Product Description

2.1. Intended Uses/Applications

MRLDS-450 Gas Detection Series instruments continuously monitor ambient air (indoor or outdoor) for the following gas types:

- Refrigerants
- Oxygen
- Toxic and combustible gases

The MRLDS-450 refrigerant gas detector is designed for use in refrigeration applications and with the integrated audio-visual alarm indication, can be operated as a stand-alone unit (with additional local alarm signaling as required), or it may be connected to a facility's building management system (BMS). It enables compliance with refrigerant safety codes (ASHRAE 15 and EN378) and alarms to alert personnel in the event of a refrigerant leak.



DANGER! This instrument is neither certified nor approved for operation in oxygen-enriched atmospheres. Failure to comply may result in EXPLOSION.



DANGER! This instrument has not been designed to be intrinsically safe for use in areas classified as being hazardous locations. For your safety, DO NOT use it in hazardous (classified) locations.

2.2. MRLDS-450

2.2.1. MRLDS-450 Product Overview

The Emerson MRLDS-450 continuously monitors indoor or outdoor ambient air for the following gases:

- Refrigerants
- Oxygen
- Toxic and combustible gases

With the integrated Modbus communication, analog output and relays, the instrument can be operated as a stand-alone unit or as a third-party device capable of accepting digital and/or analog outputs from the gas detectors, such as a Building Management System (BMS) or a Supervisory Controller. The instrument is designed to be installed in non-classified, non-hazardous, permanent locations.



Figure 2-1 - MRLDS-450

2.2.2. MRLDS-450 Design Features

- Transmitter: IP66 rated ABS enclosure
- Power options:
 - 24VAC
 - 19.5 to 28.5VDC
- Diagnostic/Status LED (3 color): Green, Orange, and Red
- Configurable output signal options
 - 3× Relays (high alarm/low alarm/fault)
 - 1× Analog Output (4 to 20mA, 0 to 5V, 0 to 10V, 1 to 5V, 2 to 10V)
 - Digital Output (Modbus RTU signal)

Bluetooth communication allows for full instrument configuration, initiation of calibration, bump test and functional test mode, and viewing of status information via the corresponding MRLDS-450 iOS/Android app.

Non-intrusive magnetic wand can be used to initiate calibration of the device.

2.2.3. MRLDS-450 Component Overview

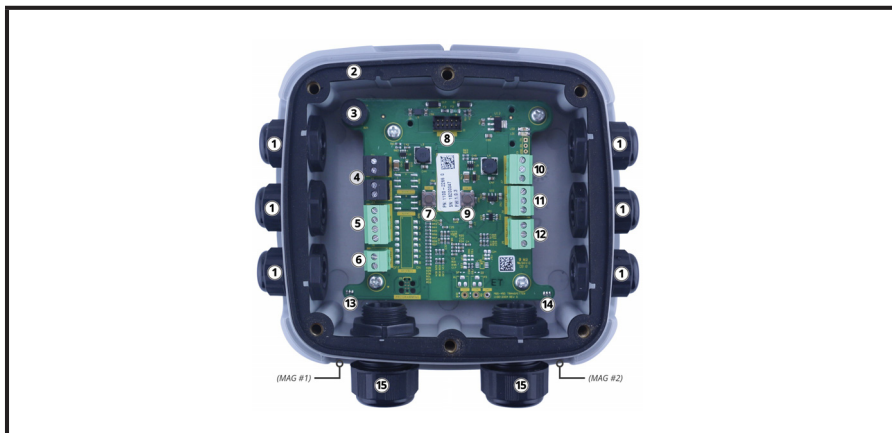

Figure 2-2 - MRLDS-450 Component Locations

#	Component Description
1	M16 Cable Glands (x6)
2	Rubber Gasket
3	Internal Alarm Buzzer
4	Power Connections (x2)
5	Digital Connection (Modbus)
6	Analog Connection
7	Tactile Switch #1
8	Ribbon Cable Connection (To Sensor)
9	Tactile Switch #2
10	Relay 3 Connection (FAULT)
11	Relay 2 Connection (HIGH)
12	Relay 1 Connection (LOW)
13	Magnetic (Mag) Switch #1
14	Magnetic (Mag) Switch #2
15	M20 Cable Glands (x2)

Table 2-1 - MRLDS-450 Component Descriptions

3 Installation



CAUTION! *The manufacturer of this product requires that a bump test or calibration be performed following installation to verify instrument functionality.*

3.1. General Information

Every detail of installation site selection is critical to ensure overall system performance and effectiveness. Strict compliance and considerable thought must be given to every detail of the installation process, including, but not limited to the following:

- Regulations as well as local, state, and national codes that govern the installation of gas monitoring equipment.
- Electrical codes that govern the routing and connection of electrical power and signal cables to gas monitoring equipment.
- The full range of environmental conditions to which the instruments will be exposed.
- The physical characteristics of the gas or vapor to be detected.
- The specifics of the application (For example, possible leaks, air movement/draft, etc.)
- The degree of accessibility required for maintenance purposes.
- The types of optional equipment and accessories that will be used with the system.
- Any limiting factors or regulations that would affect system performance or installations.
- Wiring details, including:
 - The MRLDS-450 enclosure provides the following cable gland openings:
 - 2×, M20, supports 10-14mm cable outer diameter
 - 6×, M16, supports 4-8mm cable outer diameter
 - Secondary circuit must be supplied from an isolating source.
 - The wiring for the relays must be selected and fused according to the rated voltages, currents, and environmental conditions.
 - If stranded conductions are used, ferrule should be used.
 - To comply with RFI immunity regulations, it is necessary to ground the shield of the communications cable at the PLC, GDA controller, front-end controller or Building Management System (For example, the chassis, the ground bus-bar, etc.).

3.2. Restrictions

The installation location must have appropriate supply power available for the instrument (For example, 19.5 to 28.5VDC or 24VAC). This ultimately determines the distance the instrument can be mounted from the controller or power supply.

3.3. Mechanical Installation



WARNING! DO NOT allow the lid/sensor to hang from the ribbon cable. Failure to comply may result in damage to the product.

1. Using the provided hardware, securely mount the MRLDS-450 Gas Detector according to the product dimensions, maximum wiring lengths and following considerations:
 - a. Environment: the full range of environmental conditions when selecting a location.
 - b. Application: the specifics of the application (possible leaks, air movement/draft, etc.) when selecting a location.
 - c. Accessibility: the degree of accessibility required for maintenance purposes when selecting a location.
 - d. Target Gas: the specific gravity of the target gas when selecting the height of the instrument.
 2. Using a 5/32" (4mm) hex key/allen wrench (not included) remove the lid and disconnect the ribbon cable from the base.
 3. Set the lid and rubber gasket aside to be reinstalled later.
-

3.4. Electrical Installation

3.4.1. Preparations



IMPORTANT: If analog output is configured for 4 to 20mA output, ensure that the current loop is connected to a sinking current loop monitor before powering on the instrument. Otherwise, a fault may be displayed indicating an open loop condition. If analog output is unused, ensure it is configured as a voltage output (1-5V) to prevent an open loop fault condition. The analog output is designed as sourcing.



WARNING! Ensure wiring for relays and connections for sensor(s) are made before applying power.



CAUTION! This product uses semiconductors which can be damaged by electrostatic discharge (ESD). When handling the printed circuit boards (PCBs), observe proper ESD precautions so that the electronics are not damaged.

3.4.2. Power and Signal Wiring

The product comes with cable glands and plugs pre-installed. The power entry cable gland is without a gland plug. Use the appropriate cable glands to insert and connect the wires for power and signal to the appropriate terminals as indicated in the figure and wiring table that follow. The PCB terminal blocks are a pluggable type and may be removed to aid termination.



IMPORTANT:

- For 24VAC installations sharing a transformer in a daisy-chain configuration, neutral polarity must be maintained for all instruments.
- 24VAC power polarity must not be reversed.
- For a more robust system, a dedicated transformer for each MRLDS is recommended to prevent damage caused by wiring errors.
- Fasten terminal screws.

Power	Description	Label	Wiring Termination
Power	24VDC/VAC IN	24V IN: -	24VDC/VAC neutral/ground
		24V IN: +	24VAC neutral
	24VDC/VAC OUT (power daisy chain terminal)	24V OUT: -	24VDC/VAC neutral/ground
		24V OUT: +	24VAC neutral
Digital Output	MODBUS Network Communications	MODBUS: B	RS-485 "B" (inverted)
		MODBUS: A	RS-485 "A" (non-inverted)
		MODBUS: GND	RS-485 GND
		MODBUS: SH	RS-485 Shield
Analog Output	Voltage or Current Output	ANALOG: -	Analog output ground
		ANALOG: +	Analog output signal (+)

Table 3-1 - Power and Signal Wiring

3.4.3. Relay Wiring



WARNING! Relays are rated for 0 to 30V AC/DC. DO NOT apply main power onto these relays.

Using appropriate cable glands, connect the wires for relay 1, relay 2, and relay 3 to the terminals as indicated in **Table 3-2**.

Relay	Function
1	Low Alarm
2	High Alarm
3	Fault Alarm

Table 3-2 - Relay Wiring Configuration

When configured according to the factory default settings, the relays are de-energized during normal operation (not fail-safe). Fail-safe mode can be configured. When configured for Failsafe operation, relays are energized during normal operation. Failsafe operation ensures relays are triggered in cases of power failure at the instrument. In Failsafe operation, normally open and normally closed terminals are reversed as indicated in **Table 3-3**

Terminal	Normal Operation	Failsafe Operation
NC	Normally Closed	Normally Open
COM	Common	Common
NO	Normally Open	Normally Closed

Table 3-3 - Relay Wiring Terminal Configuration

3.4.4. Modbus RTU RS-485 Interface

For the Modbus RS-485 network use a 16 to 24 AWG (0.5 to 1mm²) 3-core, 2 twisted pair + ground, shielded cable with 120Ω characteristic impedance.



IMPORTANT: Recommended: Belden 3105A (or equivalent).

The Modbus address, baud rate, stop bit, parity and slave termination is configured through the setup menu. No jumpers or hardware switch settings are required. Ensure that the communication parameters within the network, including the BMS, are configured identically.

To ensure optimal performance of the Modbus network ensure the following guidelines are implemented:

- Ensure instruments are configured in a single bus topology, connecting multiple buses in parallel or branching multiple units from the main bus, may introduce impedance mismatches, reflections and/or signal distortions.
- Avoid long stubs when connecting instruments to the bus, stubs should be less than one (1) meter in length.

- Ensure A/B signal polarity is maintained throughout RS-485 network.
- Connect cable shield drain to physical earth or ground at the controller only.
- Ensure cable shield integrity is maintained throughout RS-485 network.

For Modbus end-of-line termination, use 150Ω ohm resistor or termination block P/N 537-2711. Do not use MRLDS 120Ω ohm on-board termination with Site Supervisor or E2.

Site Supervisor Setup - Device and COMM

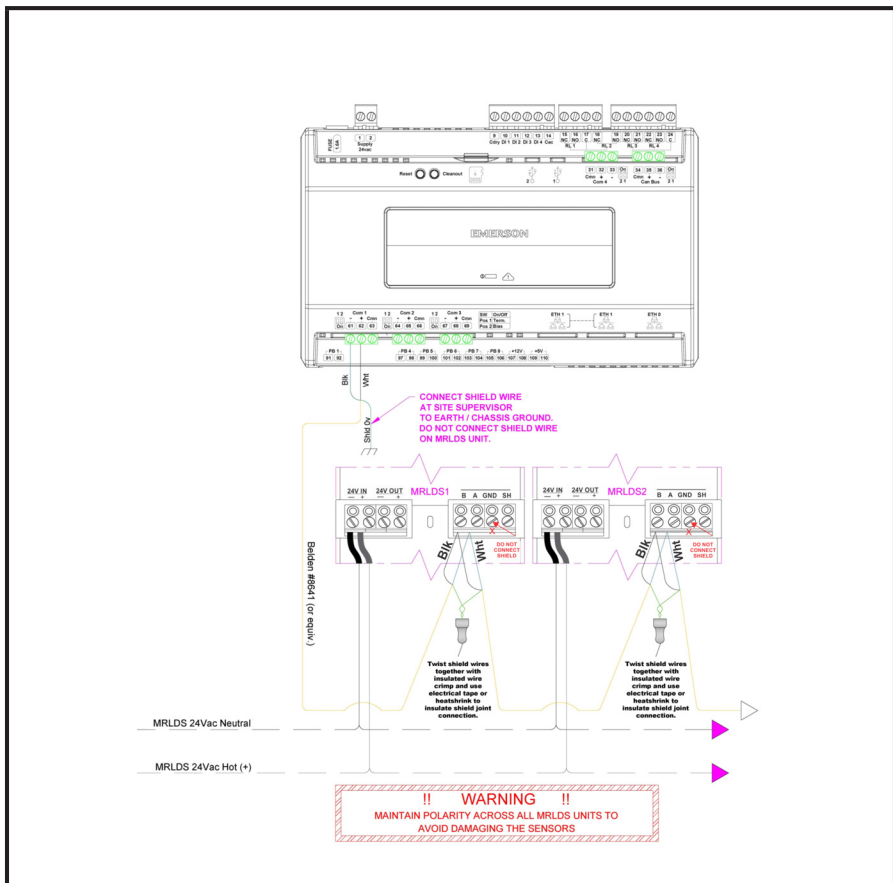

Figure 3-1 - Site Supervisor Network Setup

E2 Setup - Device and COMM

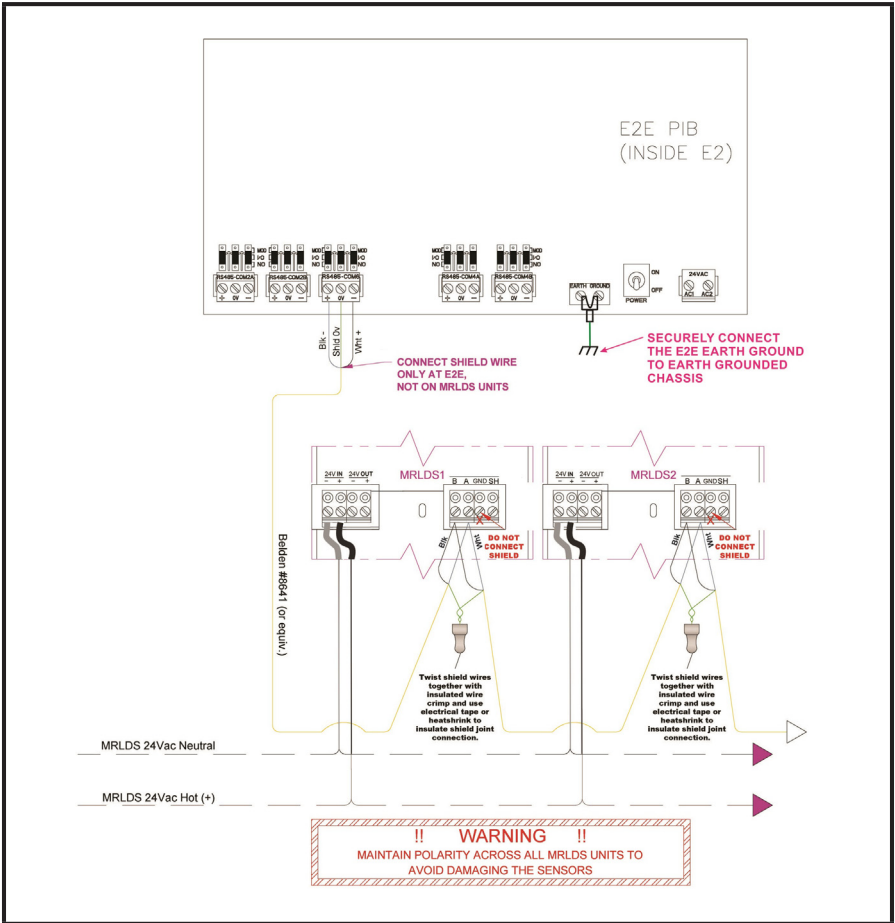

Figure 3-2 - E2 Network Setup

3.4.5. Conclusion

After all wiring is completed, power the transmitter and confirm operation, and then prepare to seal the enclosure.

Align the enclosure gasket (primary transmitter and remote sensor if equipped), replace the lid, and tighten the six (6) screws. Tightening torque should be limited to tightening by hand, and should be uniform in pattern.

3.5. Set Up MRLDS-450 Application in E2

Note: Installing the MRLDS-450 requires version E2E 4.10F01 or later. You must add a description file for version E2 3.10F01 or less.

3.5.1. New Installation: Uploading the MRLDS-450 Description File to E2

The MRLDS-450 requires adding a description file (P/N 527-0754) and license key to E2 version 3.0X or later. Contact Customer Service to obtain this information:

Email: Solutions.CustomerService@Emerson.com

Phone: 770-425-2724 Option 4

Note: UltraSite32 software should be installed to perform a description file upload.







Connect to E2 using UltraSite32

1. Launch UltraSite program and login.
2. View the **Directory Level** and then **Site Level**.
3. Right-click **Site Level** and click **Connect**.
4. Locate the E2 where the **MRLDS_450.dsc** will be installed.
5. Right-click the unit and select **Upload Description File**.
6. Click **Browse** to select the appropriate description file (5270754.dsc) file for MRLDS-450 from the computer and click **Open**.
7. Click **Upload**. A window will display the description file was successfully imported. Click **OK**. The description file should appear inside the window.
8. **Once completed, disconnect from the E2 and reboot the E2 controller.**

Note: Do not omit the step of rebooting the controller.



Device Setup

E2 Serial Port Setup

1. Log into the E2 controller.
2. Press , , , , , and  (General Controller Information), then press  twice to move to the **C3: Serial** tab.

3. Press the down arrow key to the **COM Connection** where the device is wired.
4. Press **F4** (**LOOK UP**) and select **MODBUS-1**, **MODBUS-2** or **MODBUS-3**, then press  to set configuration.
5. Press **F4** to select options and set the MODBUS connection as follows:

COM Baud:	19200 Baud
COM Data Size:	8
COM Parity	Even
COM Stop Bits:	1

6. Press  to set configuration, then  to save changes.
7. Press  to return to the *Home screen*.

Adding the MRLDS-450 Application in E2

1. Press  then **&7**, **&7**, and **@2** to enter *Connected I/O Boards and Controllers*.

- Press **F2** to move to the **C3: ECT** tab. Highlight the **MRLDS-450** application and enter the desired number of devices under **Quantity** up to a maximum of **15**.

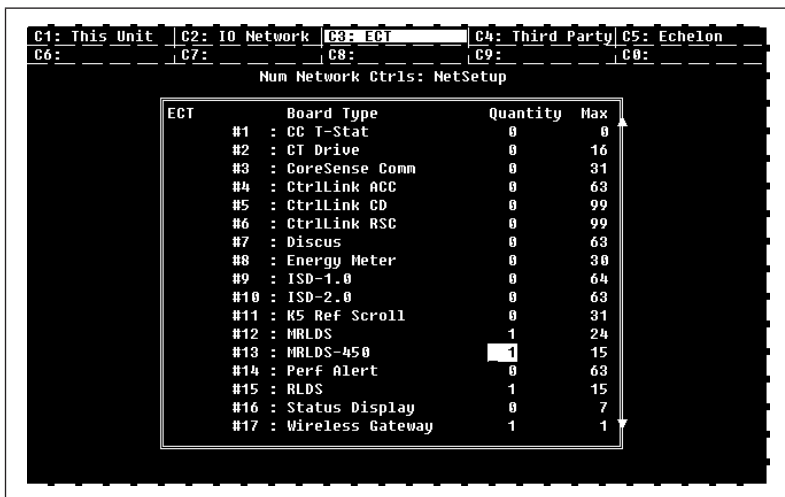





Figure 3-3- ECT Tab

- Press  to save the changes.
- Press  to return to the *Home screen*.

Commissioning the MRLDS-450

- Press  then **& 7**, **& 7**, and **! 1** to enter the *Network Summary screen*.

2. Highlight the MRLDS-450 to be commissioned and press **F4**

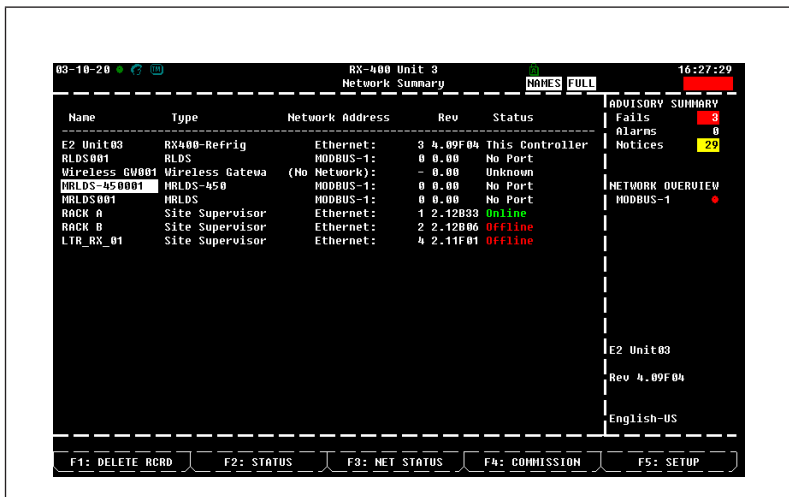

Figure 3-4- Network Summary Screen

3. If a box with **Select Network** appears on the screen, select the MODBUS number where you configured the device – either **MODBUS-1**, **MODBUS-2**, or **MODBUS-3** and press **Enter**

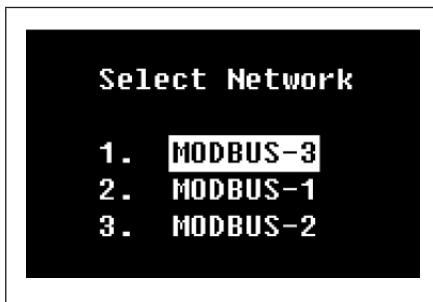



Figure 3-5- Select MODBUS output

4. Select the address for the device and press 

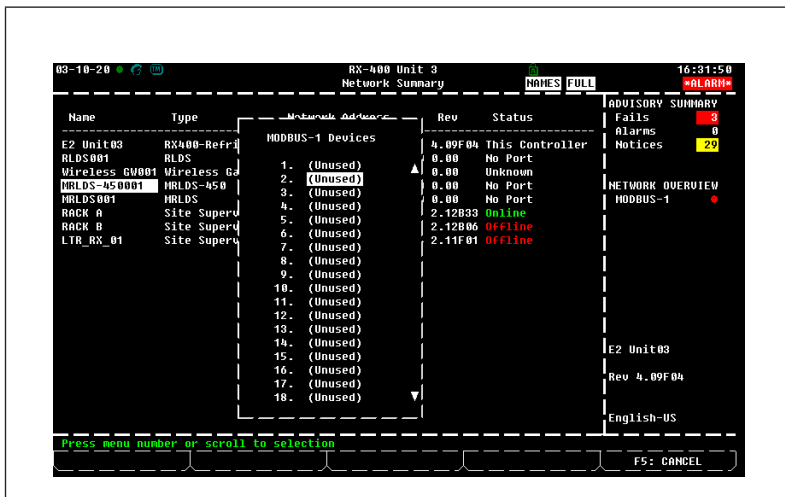



Figure 3-6- Select Device Address

Note: The MODBUS address must be the same as the address assigned on the device.

5. A window will appear. Press  to continue.

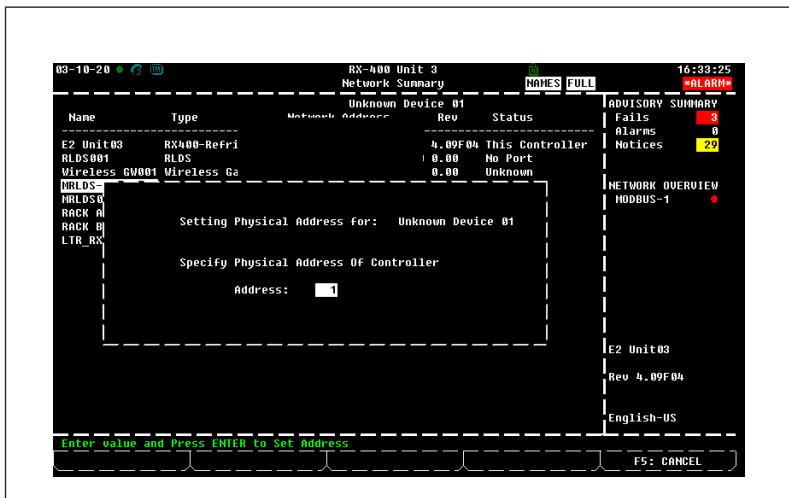







Figure 3-7- Set Physical Address for the MRLDS-450

6. Press  to save the assigned address.
7. Press  to return to the Home screen and press  then , , and  to enter the *Network Summary* screen again.

8. After a few seconds, the MRLDS-450 should appear **Online**.

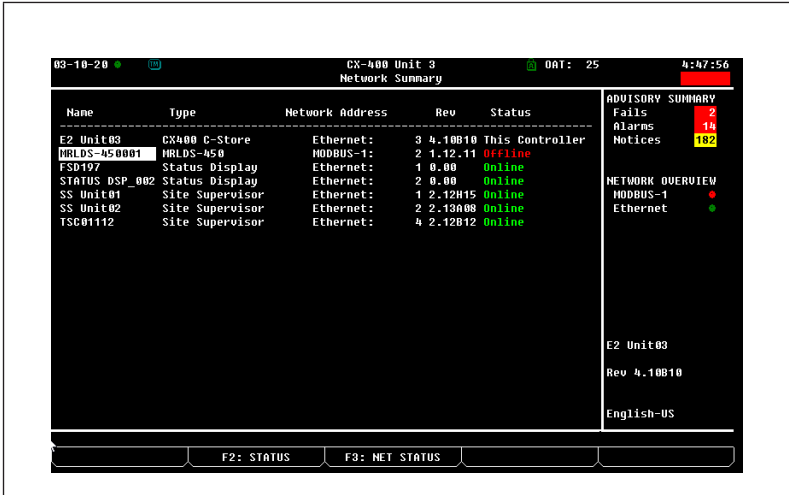

Figure 3-8- MRLDS-450 Network Summary Screen Online Status

Viewing the Status

1. Press **Menu** then **5**, **4**, **0** and **0** (this is equivalent to pressing **Menu**, **5**, **4**, **0**, **0**) or use the cursor to navigate to MRLDS-450 and press **Enter**.

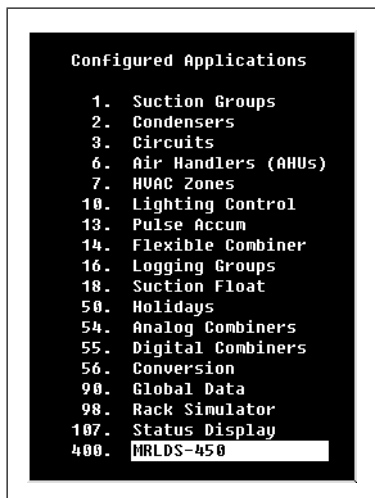

Figure 3-9- Configured Applications

- View the status of the detector on the MRLDS-450 Summary screen and press **F5** to go to **Setup**.

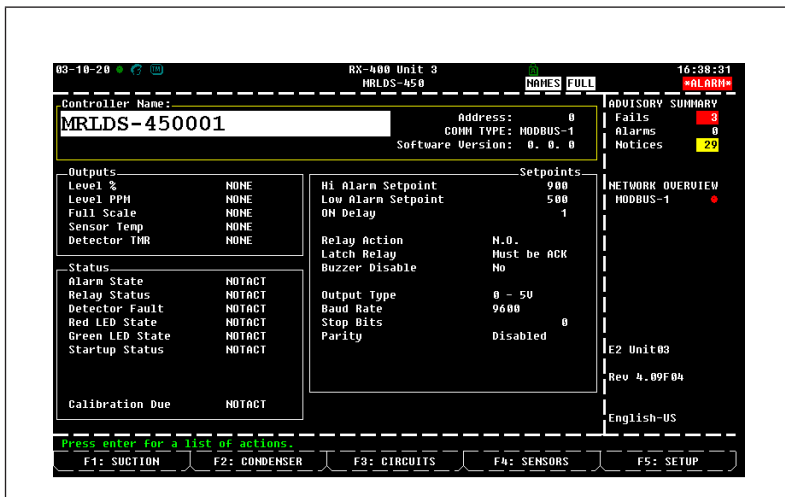

Figure 3-10-MRLDS-450 Status Screen

4 Operation

4.1. Overview of Normal Operation



CAUTION! Before leaving the instrument for normal operation, check the configuration for proper settings and check calibration.

4.1.1. Applying Power and the Start-up Sequence

After applying power, the instrument will go through a start-up sequence (initialization, audible/visual test and self-test sequence). After the start-up sequence completes, the instrument will enter a warm-up period to allow the sensor element to stabilize before reporting a valid output.

Step	Description
1	Switch power on.
2	Observe start-up sequence and warm-up phase: <ul style="list-style-type: none">• Green LED will blink at 0.5 Hz for about five (5) minutes• Modbus flag for warm-up is set• Buzzer is off• Relay state is “no alarm”• Gas reading invalid
3	Observe normal operation: <ul style="list-style-type: none">• Green LED is steady on• Modbus flag for warm-up is cleared• Buzzer is off• Relay state is “no alarm”• Gas reading valid

Table 4-1 - Instrument Start-up Sequence

4.1.2. Verifying Analog Signals

The MRLDS-450 gas detector features a single configurable analog output. During normal operation, the analog output of the instrument is proportional to the detected gas concentration and can be selected from the following:

- 1 to 5V (default)
- 0 to 5V

- 2 to 10V
- 0 to 10V
- 4 to 20mA

The MRLDS-450 Gas Detector uses different voltage/current values to indicate various modes of operation. In normal operation the relative gas concentration output is indicated by the analog output level. Output level is proportional to the gas level as shown in **Table 4-2**:

Gas Concentration	1-5V	0-5V	2-10V	0-10V	4-20mA
0%	1V	0V	2V	0V	4mA
50%	3V	2.5V	6V	5V	12mA
100%	5V	5V	10V	10V	20mA

Table 4-2 - Gas Concentration Levels

The instrument may also enter several special states, these are indicated by the specific analog output levels indicated in **Table 4-3**:

Mode of Operation	1-5V	0-5V	2-10V	0-10V	4-20mA
Instrument Fault	≤ 0.3V	N/A	≤ 0.6V	N/A	≤ 1.2mA
Offline Mode/Maintenance	0.75V	N/A	1.5V	N/A	3mA
Drift below zero	0.95V	N/A	1.9V	N/A	3.8mA
Normal operation	1-5V	0-5V	2-10V	0-10V	4-20mA
Measuring range exceeded	5.12V	5.12V	10.25V	10.25V	20.5mA
Fault on analog interface	> 5.25V	> 5.25V	> 10.5V	> 10.5V	> 21mA

Table 4-3 - Analog Output Levels

4.1.3. Verifying the Modbus Signal

The MRLDS-450 Gas Detector provides a Modbus RTU digital interface. All status messages and most parameters that can be accessed and/or configured through the Bluetooth® interface can also be accessed and/or configured via RS485 for Modbus RTU.

4.1.4. Status Indication

The MRLDS-450 gas detections provide external indication of its current operational state via audible and visual feedback. Visual indication of the instrument status is provided by a single tri-color LED (Green/Red/Orange). MRLDS-450 gas detection instruments also provide relays outputs. Instrument states and corresponding outputs are shown in **Table 4-4**.



















State	LED	Buzzer	Relay 1 (LOW)	Relay 2 (HIGH)	Relay 3 (Fault)
Warm-up			OFF	OFF	OFF
Normal			OFF	OFF	OFF
Low Alarm			ON	OFF	OFF
High Alarm			ON	ON	OFF
Offline			OFF	OFF	OFF
Fault			OFF	OFF	ON
Negative Gas Fault			OFF	OFF	ON
Zero Cal. Fault			OFF	OFF	OFF
Span Cal. Fault			OFF	OFF	OFF

Table 4-4 - Status Indicators

4.1.5. Switch Functions

User interaction with the MRLDS-450 gas detector is accomplished through the use of two magnetic switches located on the bottom of each unit. To actuate a magnetic switch, apply the supplied magnetic wand to the relevant switch location as shown in *Figure 4-1*.

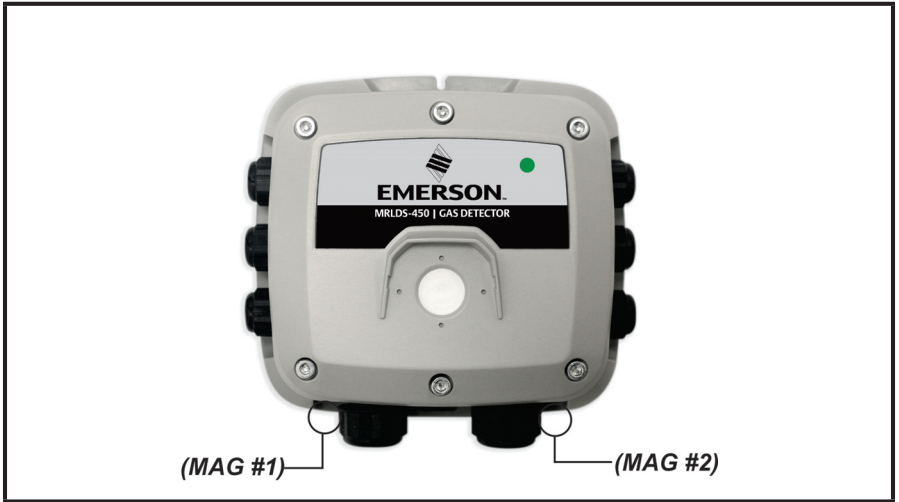

Figure 4-1 - Magnetic Switches

Switch locations above are referred to in this document as **MAG#1** and **MAG#2**. Depending on the duration the switch is held, a short “tap” or long “hold” will be detected.

- To carry out a tap function, tap the relevant switch location for one (1) second, until a single “chirp” is heard and remove the wand to confirm a “tap.”
- To carry out a hold function, do not remove the magnetic wand after the first “chirp” but continue to hold for more than five (5) seconds, until a double “chirp” is heard, and remove wand to confirm a “hold.” If either switch is held for more than 30 seconds, a stuck switch fault will be indicated.
- To interact with the instrument without use of the magnetic wand, two internal push button tactile switches may be used. Remove the lid without removing the ribbon cable to access. Internal switches **TACT#1** and **TACT#2** mirror the functions of **MAG#1** and **MAG#2**.

The function of each switch depends on the current state of the instrument. Refer to **Table 4-5** for switch functions in each instrument state.

State	Switch 1 Tap	Switch 1 Hold	Switch 2 Tap	Switch 2 Hold
Warm-up	Enable Bluetooth® Connectivity		Disable Bluetooth® Connectivity	
Normal		Start Zero Calibration		Start Span Calibration
Low Alarm		Mute Buzzer		Ack. Latched Alarm
High Alarm		Mute Buzzer		Ack. Latched Alarm
Offline				
Fault		Mute Buzzer		Ack. Latched Fault
Negative Gas Fault		Mute Buzzer		Start Zero Calibration
Zero Cal. Fault		Acknowledge Fault		
Span Cal. Fault				Acknowledge Fault

Table 4-5 - Switch Functions

4.1.6. Reset System to Factory Default Settings

To reset system to factory defaults, remove lid and hold **TACT#1** and **TACT#2** simultaneously for 30 seconds. Instrument will restart to confirm factory reset.

Alternatively, see *Section 4.2.3.4., Reset to Factory Defaults*, for instructions on resetting instrument configuration via the MRLDS-400 Series App.

4.2. MRLDS-400 Series Application

Download the MRLDS-400 Series App.

The companion smartphone application allows users to perform a variety of functions to configure and interact with the MRLDS-450 gas detector, including:

- View real-time measurements
- Configure instrument
- Test outputs
- Calibrate/Bump test instrument
- Generate customizable calibration certificates

4.2.1. Enable Bluetooth® Connection

1. Enable Bluetooth® discovery by tapping **MAG#1** for 1-second. (After 10 seconds, the device will indicate that it is discoverable with audible heartbeat until it has been paired, discovery has timed-out, or has been canceled.)

2. Launch the MRLDS-400 Series App and select the Bluetooth® icon at the bottom of the screen to initiate a scan.
3. Select MRLDS-450 default alias is “18TMAE” from the list of available gas detectors.
4. When prompted, enter the passkey (default is “123456”).



IMPORTANT: Default alias, passkey, and unlock code can be changed via the MRLDS-400 Series App’s configuration menu. Default values should be changed after instrument installation for security purposes.

4.2.2. Checking Status

Current Instrument status can be viewed from the **Home** tab. The **Home** tab displays the following status information:

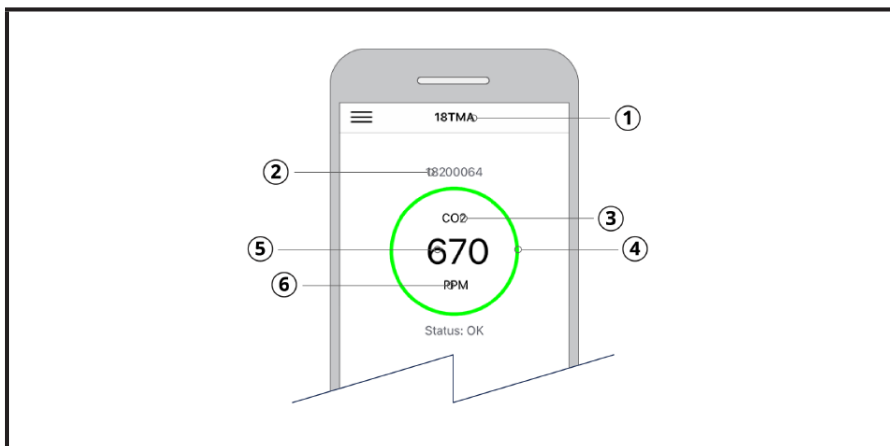

Figure 4-2 - MRLDS-400 Series App Home Tab

No.	Description
1	Alias, user-configured instrument name.
2	Serial, instrument 8-digit serial number.
3	Gas, gas type currently detected by instrument.
4	Status ring, provides visual indication of various instrument states (expanded on Table 4-7)
5	Live measurement, current measurement in given measurement units.
6	Measurement unit, displayed measurement unit (PPM/PPB/%LEL/%VOL)

Table 4-6 - MRLDS-400 Series App Home Tab Features

State	Status Ring	Description
Warm-up	Green	Gas detector stabilizing after power on or restart.
Normal	Green	Normal Operation.
Low Alarm	Yellow	Gas measurement has exceeded low alarm setpoint.
High Alarm	Red	Gas measurement has exceeded high alarm setpoint.
Offline	Orange	Gas Detector in maintenance mode and is not actively monitoring gas.
Fault	Orange	A fault has been detected.
Negative Gas Fault	Orange	Gas Detector calibration has drifted below zero, requires zero calibration.
Zero Cal. Fault	Orange	Error occurred during zero calibration. Zero calibration has not be updated. Zero calibration required.
Span Cal. Fault	Orange	Error occurred during span calibration. Span calibration has not be updated. Span calibration required.

Table 4-7 - Status Ring of Various Instrument States

4.2.3. Instrument Configuration

For security, access to configuration and calibration options are restricted to authorized users only. Access to these functions require use of an unlock code.

To unlock instrument configuration, go to the **Configure** tab to set up the device. When prompted, enter unlock code to access device configuration. (The instrument's default code is "1234"). Instrument will remain unlocked until Bluetooth® connection has ended.



IMPORTANT: Default alias, passkey, and unlock code can be changed via the MRLDS-400 Series App's configuration menu. Default values should be changed after instrument installation for security purposes.

4.2.3.1. Change Alias

To allow easy identification of a given instrument, an alias can be assigned to each instrument. This alias is displayed when searching for an instrument via Bluetooth®, on Calibration Cert and in the **Home** tab. To set the alias:

- On the **Configure** tab select **Alias**. Enter the required alias for instrument and select **OK**.
- The instrument must be restarted for change to take effect. Selecting the **Home** tab then **Restart** will reboot device.
- Reconnect to instrument to confirm the alias has been updated.

4.2.3.2. Change Unlock Code

To prevent unauthorized access to instrument configuration and calibration, the default instrument unlock code should be changed during commissioning. To change unlock code:

- On the **Configure** tab select **Modbus Unlock Code**. Enter the new 4-digit unlock code for instrument and select **OK**.
- The instrument must be restarted for changes to take effect. Selecting the **Home** tab, then **Restart** will reboot the device.
- Reconnect to instrument to confirm the unlock code has been updated.



***IMPORTANT:** If the custom unlock code is forgotten, the unlock code may be reset to default value (1234) by resetting system to factory defaults. Refer to Section 4.1.6., **Reset System to Factory Default Settings** for the system reset procedure. Note that a system reset will return all custom system configurations to defaults.*

4.2.3.3. Change Bluetooth® Passcode

To prevent unauthorized access to instrument status, the default instrument Bluetooth® passcode code should be changed during commissioning. To change Bluetooth® passcode:

- On the **Configure** tab select **Bluetooth Passcode**. Enter new 6-digit passcode for the instrument and select **OK**.
- The instrument must be restarted for changes to take effect. Selecting the **Home** tab, then **Restart** will reboot the device.
- Reconnect to instrument to confirm the Bluetooth® Passcode has been updated.



***IMPORTANT:** If the custom passcode is forgotten, the unlock code may be reset to default value (123456) by resetting system to factory defaults. Refer to Section 4.1.6., **Reset System to Factory Default Settings** for system reset procedure. Note that a system reset will return all custom system configurations to defaults.*

4.2.3.4. Reset to Factory Defaults

Instrument configuration may be reset to factory defaults via the smartphone application:

- On the **Configure** tab select **Reset to Factory Default** and select **OK** to confirm.
- The instrument will automatically restart and disconnect from the smartphone application.



WARNING! Resetting system to factory defaults will remove all custom system configuration including unlock code and Bluetooth passcode. After system reset custom unlock and Bluetooth passcodes should be configured to prevent unauthorized access and reconfiguration of instrument.

4.2.3.5. Alarm Configuration

Low Alarm Setpoint

The value above which a low alarm condition occurs. The low alarm setpoint must be less than the high alarm setpoint and greater than the low alarm limit. The low alarm limit is the fixed minimum limit that is sensor-specific and not editable.

Range of acceptable setpoints is displayed when updating the parameter. To update the setpoint:

- On the **Configure** tab select **Alarm** then **Low Alarm Setpoint**. Enter the new setpoint and select **OK** to confirm.



IMPORTANT: In instruments with an oxygen sensor installed, low alarm behavior operates in a depletion mode where gas measurements **BELOW** the low alarm setpoint initiate a low alarm. This allows monitoring of oxygen displacement and enrichment scenarios.



IMPORTANT: To prevent intermittent alarm operation at the setpoint due to measurement noise this instrument implements hysteresis at the setpoint. Once the alarm level is exceeded, the gas measurement must return a fixed percentage below the alarm threshold before the alarm is disabled. Typical hysteresis value is set at 5% of full scale; however, this is sensor-specific and non-editable.

High Alarm Setpoint

The value above which a high alarm condition occurs. The high alarm setpoint must be less than the sensor full scale range and greater than the low alarm setpoint.

Range of acceptable setpoints is displayed when updating the parameter. To update setpoint:

- On the **Configure** tab select **Alarm** then **High Alarm Setpoint**. Enter the new setpoint and select **OK** to confirm.
-



IMPORTANT: To prevent intermittent alarm operation at the setpoint due to measurement noise, this instrument implements hysteresis at the setpoint. Once the alarm level is exceeded, the gas measurement must return a fixed percentage below the alarm threshold before the alarm is disabled. Typical hysteresis value is set at 5% of full scale; however, this is sensor-specific and non-editable.

Alarm Latching

Enabling alarm latching will maintain alarm or fault condition even after the alarm or fault condition is no longer active. When latched, the alarm or fault condition must be manually acknowledged before the condition will be cleared. This allows transient alarm or fault conditions to be identified.

If an alarm is latched, for example, the condition has occurred but is no longer active, an acknowledgment button will appear on the Home screen. Select this button to acknowledge the latched condition and clear the alarm or fault.

When disabled, the alarm or fault status clears automatically as soon as the condition is no longer active. To configure:

- On the **Configure** tab select **Alarm** then **Alarm Latching**. Select **Enable/Disable** and **OK** to confirm.

4.2.3.6. Modbus Configuration

Address

Sets instrument address for connection to RS-485 Modbus interface. (Default: 1).
To set address:

- On the **Configure** tab select **Modus**, then **Address**. Select 1-247 and **OK** to confirm.



IMPORTANT: Ensure all instruments on RS-485 bus have been configured with unique node addresses. If two instruments have been configured with same address, bus contention will occur preventing communications with these instruments via the RS-485 interface.

Baud Rate

Sets instrument baud rate for connection to RS-485 Modbus interface baud).
To set baud rate:

- On the **Configure** tab select **Modus** then **Baud Rate**. Select **9600/19200** (default) and **OK** to confirm.

Stop Bits

Sets instrument stop bits for connection to RS-485 Modbus interface (Default: 1 stop bits). To set number of stop bits:

- On the **Configure** tab select **Modus** then select **Stop Bits**. Select **1** or **2** and **OK** to confirm.

Parity

Sets instrument parity for connection to RS-485 Modbus interface (**None**, **Odd**, or **Even** (default)).

To set parity:

- On the **Configure** tab select **Modus** then select **Parity**. Select **None/Odd/Even** and **OK** to confirm.



IMPORTANT: Stop bits must be set to 1 where parity is Odd or Even.

Enable 120Ω Termination

For optimal communication reliability, in RS-485 Modbus networks the last instrument physically connected to the RS-485 bus must include a 120Ω termination resistor. This is to reduce the potential for electrical signal reflection on long buses due to impedance mismatches. Typically, this requires a physical resistor with the same characteristic impedance of the bus cable to be installed on the bus.

MRLDS-450 instruments include this termination resistor on all instruments and allow this termination to be enabled via this configuration setting without the need for an external physical resistor. To enable this termination resistor:

- On the **Configure** tab select **Modbus** then select **Enable 120Ω Termination**. Select **Enable/Disable** and select **OK** to confirm.



IMPORTANT: Termination resistor should only be enabled on last instrument physically connected to RS-485 bus. An external resistor should not be connected where this is enabled on the instrument.

4.2.3.7. Output Configuration

Analog Output Range

Sets instrument analog output range. Available ranges: 1-5V (default), 0-5V, 0-10V, 2-10V, 4-20mA. To set range:

- On the **Configure** tab select **Outputs**, then select **Analog Output Range**. Select desired range and select **OK** to confirm.
-

Buzzer

Enable or disable buzzer. Buzzer provides local audible alarm/fault indication. Buzzer is enabled by default. To enable/disable buzzer:

- On the **Configure** tab select **Outputs**, then **Buzzer**. Select **Enable/Disable** and select **OK** to confirm.

Relay Failsafe

Enable or disable Relay Failsafe operation. When configured for fail-safe operation, relays are energized during normal operation. Failsafe operation ensures relays are triggered in cases of power failure at the instrument. In Failsafe operation, normally open and normally closed terminals are reversed as indicated in **Section 3.4.3., Relay Wiring**. Relays are configured as non-Failsafe by default. To enable/disable relay Failsafe:

- On the **Configure** tab select **Outputs** then **Relay Failsafe**. Select **Enable/Disable** and **OK** to confirm.

Alarm Delay

Sets delay in minutes before instrument will indicate an alarm condition after low or high alarm threshold has been exceeded. May be used to prevent short transient alarm conditions from activating alarms. Alarm delays may be set for 0-15 minutes. Alarm delay is configured as 0 minutes by default. To set alarm delay:

- On the **Configure** tab select **Outputs** then **Alarm Delay**. Enter the desired delay in minutes (0-15) and **OK** to confirm.

Analog Zero Adjust

Analog zero adjust applies a fixed offset to the analog output. This allows removal of small errors in the output between the gas detection instrument and the measurement at the controller due to cable resistance when using voltage outputs.

To apply adjustment ensure instrument is outputting fixed voltage (default 1V at zero ppm or use output test function to set specific voltage value), monitor remote measurement and adjust zero offset until remote measurement matches expected voltage output. Adjustment is limited to $\pm 10\%$ full scale. To set analog zero adjustment:

- On the **Configure** tab select **Outputs** then **Analog Zero Adjust**. Use the slider to set desired offset adjustment.
- Alternatively, select “Analog Zero Adjust (X.X%)” text and enter specific offset required (-10 to 10).

Analog Span Range

Analog span range scales the FSD (full-scale deflection) of the analog output. The selected range determines the equivalent gas measurement at the analog output maximum range.

Example: R134A 1000ppm, 0-5V analog output. If Analog Span Range is set to 20%, the full analog output range only covers the first 20% of the gas measurement range, for example, 0-200ppm will output 0-5V, above 200ppm the output will be truncated to 5V. *Note that sensor resolution stays at the value for the max range.*

To set analog span range:

- On the **Configure** tab select **Outputs** then **Analog Span Range**. Use the slider to set desired range.
- Alternatively, select “Analog Span Range (X.X%)” text and enter specific offset required.

5 Care and Maintenance

5.1. Maintenance Intervals

Interval	Function
During Commissioning	Check calibration
	Check LEDs for proper operation*
	Check for proper buzzer and relay operation*
	Check signal transmission to the BMS/BAS (central controller) if connected*
Every 6-12 Months**	Inspection by trained service personnel.
	Check LEDs for proper operation*
	Check for proper buzzer and relay operation*
	Check signal transmission to the BMS/BAS (central controller) if connected*
	Calibrate the sensor or contact Emerson Technical Support for sensor exchange with factory - calibrated sensor
As Required	Replace sensor module(s)

Table 5-1 - Maintenance Intervals and Functions

* These can be activated via Modbus commands or via MRLDS-400 Series App.

** Typical maintenance frequency can vary by sensor type.

Sensor Type	Recommended Maintenance Interval	Typical Sensor Lifetime
Electrochemical*	12 months	2-3 years
Catalytic Bead	Zero calibration -1-3 months Span calibration - 6 months	5-7 years
Semiconductor*	6 months after commissioning 12 months thereafter	4-6 years
Infrared	12 months	5-7 years

Table 5-2 - Maintenance Intervals and Functions

* Sensors should be checked after exposure to significant concentrations of gas, which can shorten the sensor lifetime and/or reduce its sensitivity.

5.2. Adjustments

5.2.1. Introduction

Adjustment of the detector must be performed at regular intervals as required by national standards or regulations (*For example, EN 378, ASHRAE 15, BREEAM, etc.*).



Breathing Hazard: Calibration gas ***MUST NOT*** be inhaled! See appropriate Safety Data Sheets. Calibration gas should be vented into a fume hood or to the outside of the building.



Zero First, Then Span: For proper operation, never adjust the span before completing a zero adjustment. Performing these operations out of order will cause faulty calibration.



***IMPORTANT:** Emerson recommends calibrating detectors within the application-specific condition and with target gas. This method of zeroing the detector in the application environment and performing a target gas calibration is more accurate. A surrogate gas calibration may only be performed as an alternative if a target gas calibration is not possible.*



***IMPORTANT:** The sensor should be fully stabilized (at least 2 hours, preferably 24 hours).*



***IMPORTANT:** When entering the functions for zero or span adjustment, the detector will automatically enter OFFLINE mode, and will remain OFFLINE until either the OFFLINE mode is canceled by tapping the respective magnetic switch, or the OFFLINE mode times out within 6 minutes (typical) after the adjustment has ended.*

5.2.2. General Calibration Procedure



***IMPORTANT:** The MRLDS-450 Gas Detector **MAY NOT** be in an alarm or fault condition during calibration. Acknowledge any alarms or faults **BEFORE** attempting to begin the calibration process.*



***IMPORTANT:** Except for CO₂ or O₂ sensors, calibration gas must be in a balance of air, not nitrogen (N₂).*



IMPORTANT: Calibration and/or bump testing requires the MRLDS-450 Calibration Adapter Kit (P/N 809-1190).



IMPORTANT: At elevations higher than 6,560' (ft) (3,000 m), calibration will result in a lower reading. Above 6,560' (ft), the instrument should be calibrated in the environment of operation.

1. Fit calibration adapter to the gas detector lid.



Figure 5-1 - Calibration Adapter Fitting

2. If using a variable flow regulator, adjust the gas flow to approximately 0.3 L/min.

5.2.3. Zero Adjustment

Ambient air can be used to zero the sensor instead of synthetic air only if the area is known to be free of the target gas or any gas to which the sensor may be cross-sensitive. In this case, no cylinder or calibration adapter is needed for the zero adjustment.



IMPORTANT: The MRLDS-450 **MAY NOT** be in an alarm or fault condition during calibration. Acknowledge any alarms or faults **BEFORE** attempting to begin the calibration process.



IMPORTANT: Except for CO₂ or O₂ sensors, ambient air may be used instead of zero gas if the area is known to be free of the target gas or any gases to which the sensor may be cross-sensitive.

1. Begin zero adjustment:
 - a. **MRLDS-400 App:** On the **Home** tab select **Calibrate** then scan the barcode on gas cylinder or manually enter values for zero gas.
 - b. **Manual:** Hold **MAG#1** for more than five (5) seconds. The LED will blink GREEN-GREEN-RED when the instrument is ready.
2. Apply zero gas (or ambient air per warning above).
3. Confirm the start of calibration:
 - a. **MRLDS-400 App:** Press the **Start Zero** button.
 - b. **Manual:** Tap **MAG#1** within 30 seconds or the instrument will time-out and return to normal operation.
4. Complete zero adjustment:
 - a. **MRLDS-400 App:** App will countdown to completion. If calibration is successful, proceed to *Step 5*. If calibration is unsuccessful, return to the Home screen and press the Acknowledge button to clear the zero calibration fault.
 - b. **Manual:** The LED will blink GREEN-RED, GREEN-RED-RED, GREEN-RED-RED-RED, etc. until calibration is complete. To abort, hold **MAG#1** for >5-seconds, turn off gas flow and remove the calibration adapter. If calibration is successful (green LED), proceed to *Step 5*. If calibration is unsuccessful (LED blinks orange @ 2 Hz), tap **MAG#1** to discard the calibration attempt.
5. Turn off gas flow from zero gas.
6. Replace zero gas with calibration gas in preparation for span adjustment.

5.2.4. Span Adjustment



IMPORTANT: Except for CO₂ or O₂ sensors, calibration gas must be in a balance of air, not nitrogen (N₂).



IMPORTANT: At elevations higher than 6,560' (ft) (2,000 m), calibration will result in a lower reading. Above 6,560' (ft) the instrument should be calibrated in the environment of operation.

1. Begin span adjustment:
 - a. **MRLDS-400 App:** Scan barcode on gas cylinder or manually enter values for zero gas.
 - b. **Manual:** Hold **MAG#2** for more than five (5) seconds. The LED will blink GREEN-GREEN-ORANGE when the instrument is ready.
2. Apply calibration gas at the concentration listed on the calibration gas concentration label (located on top of the instrument).
 - Part Number
 - Serial Number
 - Sensor Type
 - Maximum Range
3. Confirm the start of calibration:

- a. **MRLDS-400 App:** Press the **Start Span** button.
 - b. **Manual:** Tap **MAG#2** within 30 seconds or the instrument will time-out and return to normal operation.
4. Complete zero adjustment:
- a. **MRLDS-400 App:** App will countdown to completion. If calibration is successful, proceed to *Step 5*. If calibration is unsuccessful, return to the Home screen and press the Acknowledge button to clear the zero calibration fault.
 - b. **Manual:** The LED will blink GREEN-ORANGE, GREEN-ORANGE-ORANGE, GREEN-ORANGE-ORANGE-ORANGE, etc. until calibration is complete. To abort, hold **MAG#2** for >5-seconds, turn off gas flow and remove the calibration adapter. If calibration is successful (LED blinks green-orange-red), proceed to *Step 5*. If calibration is unsuccessful (LED blinks orange @ 2 Hz), tap **MAG#2** to discard the calibration attempt.
5. Turn off gas flow from calibration gas and remove the calibration adapter.
6. Allow sensor to recover/stabilize before the instrument returns to normal operation (green LED).

5.2.5. System Bump Test

A bump test is a live test of the system to verify that the detector responds to gas and all connected alarm devices, BMS, etc. are operating accordingly. It is recommended that all involved persons are informed about the test and certain alarms might have to be inhibited (For example, shutdown valves, notification of authorities, etc.).



IMPORTANT: *The manufacturer of this product requires that a bump test or calibration be performed following installation to verify instrument functionality.*

1. Connect adapter and gas cylinder according to the instructions in the General Calibration Procedure.
2. If desired, disable/silence external annunciators (For example, shutdown valves, notification of authorities, etc.):
 - a. **MRLDS-400 App:** On the **Home** tab select **Calibrate** then **Bump**. Toggle **TAKE OFFLINE** to disable communications to external devices.
 - b. **Manual:** Inform building personnel of test so that external devices can be disabled/silenced.
3. Apply a sufficiently high concentration of the target gas to trigger alarms, but NOT pure refrigerant or hydrocarbons (For example, do not use a butane lighter).
4. Once thresholds have been exceeded, relays should activate, digital outputs should transmit the gas concentration and:
 - a. **MRLDS-400 App:** Gas concentration should be displayed, the instrument status should be **LOW ALARM** or **HIGH ALARM** and alarms states should be **ON**.
 - b. **Manual:** LED status should display **LOW ALARM** or **HIGH ALARM**.
5. Turn off gas flow and remove the calibration adapter.

6. Allow sensor to recover/stabilize before the instrument returns to normal operation (green LED).

5.3. Troubleshooting

5.3.1. Hexadecimal Format

All fault codes can be retrieved through the Modbus interface and are shown in hexadecimal (hex) format. A hex digit can represent multiple codes as shown below:

Hex Code	Equivalent Error Code(s)
0	0
1	1
2	2
3	1+2
4	4
5	1+4

Hex Code	Equivalent Error Code(s)
6	1+2+3
7	1+2+4
8	8
9	1+8
A	2+8
B	1+2+8

Hex Code	Equivalent Error Code(s)
D	1+4+8
E	2+4+8
F	1+2+4+8

Table 5-3 - Hexadecimal Code Format

5.3.2. Fault Codes



IMPORTANT: If a sensor fault occurs during a gas alarm condition, then the fault overrides the alarm condition.

Sensor faults may be decoded using the following table. Note that several faults may be reported at the same time. For example, fault code “00000003” is a combination of fault codes 00000001 (No sensor signal) and 00000002 (Voltage out of specification 1V).



IMPORTANT: If a “last fault” attribute indicates that a fault has occurred at some point in time, but the corresponding “current fault” attribute shows no fault, then the problem has self-healed and no service action is required.

Fault Bit	System Fault	Possible Cause	Required Action(s)
0x00000001	Software fault	Firmware error (e.g. unexpected state)	Power-cycle. If it re-occurs, call product support
0x00000002	Voltage out of specification 1V	Voltage rail out of range	Call product support
0x00000004	Voltage out of specification 3.3V	Voltage rail out of range	
0x00000008	Voltage out of specification 5V	Voltage rail out of range	
0x00000010	Voltage out of specification 5.4V	Voltage rail out of range	
0x00000020	Voltage out of specification 12V	Voltage rail out of range	
0x00000040	Voltage out of specification VIN	Voltage rail out of range	
0x00000080	System Flash Memory Read Fault	Error reading from internal Flash	Power-cycle. If it re-occurs, call product support
0x00000100	System Flash Memory Write Fault	Error writing to internal Flash	
0x00000200	System Flash Memory CRC fault	Error in internal Flash CRC	
0x00000400	System Invalid Configuration	Error in system configuration	
0x00000800	GPIO fault	Error detected on GPIO pin	Call product support
0x00001000	Modbus Fault	Error detected in Modbus Communications	Power-cycle. If it re-occurs, call product support
0x00002000	Analog Output Fault (MRLDS-450 Only)	Error updating DAC value	
0x00004000	Bluetooth Fault	Error detected in Bluetooth module	
0x00008000	Stuck switch	Magnetic and/or Tactile switch activated for > 1 minute	Call product support
0x00010000	Sensor Element Out	Cannot detect sensor element	Check sensor connection
0x00020000	Sensor Element Fault	Fault detected in sensor element	Replace sensor nodule

Table 5-4 - Sensor Fault Codes

Fault Bit	System Fault	Possible Cause	Required Action(s)
0x00040000	Sensor ADC Sensor Read Fault	Cannot read from sensor ADC	Check sensor connection/ Replace Sensor Module
0x00080000	Sensor ADC Current Read Fault	Cannot read from current ADC	
0x00100000	Sensor AFE Read Fault (EC only)	Cannot read from EC sensor AFE	
0x00200000	Sensor AFE Write Fault (EC only)	Cannot write to EC sensor AFE	
0x00400000	Sensor AFE Status Fault (EC only)	Error in EC sensor AFE	
0x00800000	Sensor EEPROM Read Fault	Error in reading from sensor EEPROM	Power-cycle / check sensor connection / replace sensor module
0x01000000	Sensor EEPROM Write Fault	Error in writing to sensor EEPROM	Call product support
0x02000000	Sensor EEPROM CRC Fault	Error in CRC from sensor EEPROM	Power-cycle / replace sensor module
0x04000000	Sensor EEPROM Configuration Fault	Error in sensor EEPROM data	Replace sensor module
0x08000000	Sensor UART Read Fault	Cannot read from sensor UART	Check sensor connection / replace sensor module
0x10000000	Sensor Temperature Fault	Temperature cannot be read or is out of specification	Ensure sensor is operating within specified temperature range / check sensor connections
0x20000000	Negative Gas Concentration Fault	Sensor output has drifted too negative	Initiate zero calibration (Via App / Hold MAG#2)
0x40000000	Zero Calibration failure	Zero calibration failed	Acknowledge failed calibration (Via App / Hold MAG#1)
0x80000000	Span Calibration failure	Span calibration failed	Acknowledge failed calibration (Via App / Hold MAG#2)

Table 5-4 - Sensor Fault Codes

5.4. Sensor Maintenance



CAUTION! This product uses semiconductors that can be damaged by electrostatic discharge (ESD). When handling the PCB, care must be taken so that the electronics are not damaged.

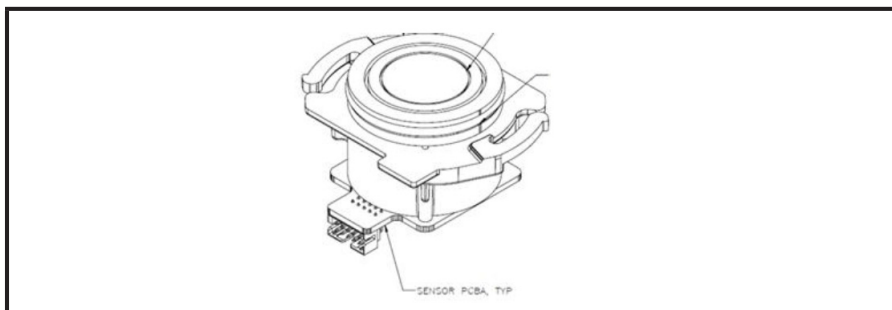

Figure 5-2 - MRLDS-450 Components

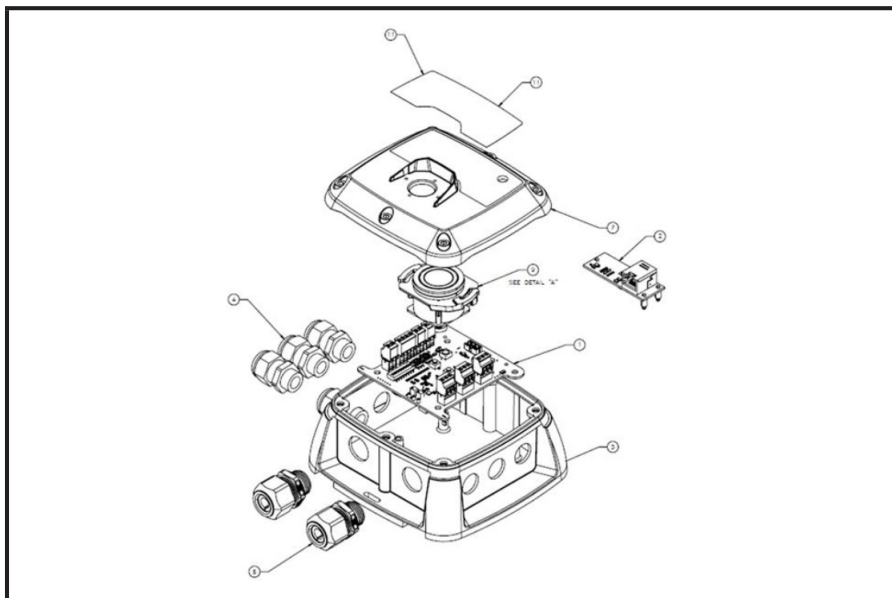

Figure 5-3 - IP66 Sensor Configuration

IP66 Product arrangement shown for reference; Remote Daughterboard PCB shown (used for Remote IP66 Sensor Configurations). *Note: Cable Glands and labeling are factory installed.*

5.4.1. Replacing Sensor Module



CAUTION! *This product uses semiconductors that can be damaged by electrostatic discharge (ESD). When handling the PCB, care must be taken so that electronics are not damaged.*

To replace the gas detector's sensor module:

1. Power-down the gas detector.
2. Using a 5/32" (4mm) hex key/allen wrench (not included), remove the lid and disconnect the ribbon cable from the sensor module.
3. Remove installed sensor module from the lid by holding onto the housing and turning counter-clockwise 90°. Take care not to apply excessive force to the sensor module's circuit board. When the square tab of the sensor housing is aligned with the lock icon, firmly pull the module to remove it from the housing.
4. Install the new sensor module by aligning the square tab with the lock icon before firmly pressing it into the enclosure. Taking care not to apply excessive force to the sensor module's circuit board, rotate the sensor module clockwise 90° (or until the triangle icon aligns with the lock icon on the lid).
5. Connect the ribbon cable (to the sensor module and transmitter) and close the lid.
6. Ensure gasket is aligned correctly and tighten the lid using the supplied hardware in an "X" pattern. Tightening torque should be limited to hand tight and should be uniform.



Figure 5-4 - Tightening Pattern

7. Power-up the gas detector.
8. After the start-up sequence has finished, check sensor response (bump test).

5.5. Cleaning the Instrument

Clean the detector with a soft cloth using water and a mild detergent. Rinse with water. Do not use any alcohols, cleaning agents, sprays, polishes, detergents, etc.

6 Additional Information

6.1. Sensor Principle

6.1.1. Electrochemical Sensors

Electrochemical sensors measure the partial pressure of gases under atmospheric conditions. The monitored ambient air diffuses through a membrane into the liquid electrolyte in the sensor. The electrolyte contains a measuring electrode, a counter-electrode, and a reference electrode. An electronic “potentiostat” circuit ensures a constant electrical voltage between measuring electrode and reference electrode. Voltage, electrolyte, and electrode material are selected to suit the gas being monitored so that it is transformed electrochemically on the measuring electrode and a current flows through the sensor. This current is proportional to the gas concentration. At the same time, oxygen from the ambient air reacts at the counter electrode electrochemically. The current flowing through the sensor is amplified electronically, digitized and corrected for several parameters (For example, the ambient temperature).

6.1.2. Catalytic Bead Sensors

A catalytic bead sensor measures the partial pressure of combustible gases and vapors in ambient air. It uses the heat-of-combustion principle.

The monitored air diffuses through the sintered metal disc into the sensor. The mixture of combustible gases, vapors, and air are catalytically combusted at a heated detector element (called a pellistor). The oxygen content in the air must be greater than 12 Vol%. Due to the resulting heat-of-combustion, the temperature of the detector element rises. This increase in temperature causes a change of resistance in the detector element, which is proportional to the concentration of the mixture of combustible gases and vapors in the monitored air. In addition to the catalytically active detector element, there is a compensator element. Both elements are parts of a Wheatstone bridge. Thus environmental effects like changes in ambient temperature or humidity are almost entirely compensated.



IMPORTANT: *Certain substances in the atmosphere to be monitored may impair the sensitivity of the sensors. Such substances include, but are not limited to:*

- 1. Polymerizing substances such as acrylonitrile, butadiene, and styrene.*
 - 2. Corrosive compounds such as halogenated hydrocarbons (releasing halogens such as bromine, chlorine or fluorine when oxidized) and halogen hydride acids as well as acidic gaseous compounds such as sulfur dioxide and nitrogen oxides, Catalyst poisons such as sulfurous and phosphorous compounds, silicon compounds (especially silicones), and metal-organic vapors.*
-

It may be necessary to check the calibration if the sensor has been exposed for a long time to a high concentration of flammable gases, vapors, or the above-mentioned contaminating substances.

The nature of catalytic bead sensor technology means that sensor drift may typically be up to $\pm 5\%$ LEL per month. Instruments using these sensors should be zeroed regularly following the instructions in **Section 5, Care and Maintenance**.

6.1.3. Semiconductor Sensors

Semiconductor or metallic oxide sensors (MOSs) are among the most versatile of all broad-range sensors. They can be used to detect a variety of gases and vapors in low ppm or even combustible ranges. The sensor is made up of a mixture of metallic oxides. They are heated to a temperature between 302°F and 572°F (150°C and 300°C) depending on the gas(es) to be detected. The temperature of operation as well as the “recipe” of mixed oxides determines the sensor selectivity to various toxic gases, vapors, and refrigerants. Electrical conductivity greatly increases as soon as a diffusion process allows the gas or vapor molecules to come in contact with the sensor surface. Water vapor, high ambient humidity, temperature fluctuations, and low oxygen levels can result in higher readings.



IMPORTANT: *Certain substances in the environment to be monitored may impair the sensitivity of the sensors:*

1. *Materials containing silicone or silicone rubber/putty.*
 2. *Corrosive gases such as hydrogen sulfide, sulfur oxide, chlorine, hydrogen chloride, etc.*
 3. *Alkaline metals, saltwater spray.*
-

6.1.4. Infrared Sensors

The infrared (IR) gas sensor is designed to measure the concentration of combustible gases and vapors in the ambient air. The sensor principle is based on the concentration-dependent absorption of infrared radiation in measured gases.

The monitored ambient air diffuses through a sintered metal material into the enclosure of an optical “bench.” The broadband light emitted by an IR source passes through the gas in the optical bench and is reflected by the walls from where it is directed towards a dual-element detector. One channel of the detector measures the gas-dependent light transmission, while the other channel is used as a reference. The ratio between measurement and reference signal is used to determine the gas concentration. Internal electronics and software calculate the concentration and produce an output signal.

6.2. Disposing of the Instrument

6.2.1. Disposing of the Electrical and Electronic Equipment

EU-wide regulations governing the disposal of electrical and electronic appliances which have been defined in the EU Directive 2012/19/EU and in national laws have been effective since August 2012 and apply to this device.

Common household appliances can be disposed of using special collecting and recycling facilities. However, this device has not been registered for household usage. Therefore it must not be disposed of through these channels. The device can be returned to Emerson for disposal. Please do not hesitate to contact Emerson Technical Support if you have any further questions on this issue.

6.2.2. Disposing of Sensors

Dispose of sensors in accordance with local laws.



DANGER! Do not dispose of sensors in fire due to the risk of explosion and resulting chemical burns.



WARNING! Do not force open electrochemical sensors.



IMPORTANT: Observe the applicable local waste disposal regulations. For information, consult your local environmental agency, local government offices or appropriate waste disposal companies.

6.3. Technical Specifications

6.3.1. General Specifications

Category	Specifications	
Signals to Central Controller	Analog Current	Normal operation: 4 to 20mA
		Drift below zero: 3.8mA
		Measuring range exceeded: 20.5mA
		Instrument fault: $\leq 1.2\text{mA}$
		Fault on analog interface: $> 21\text{mA}$
		Offline mode/Maintenance signal: 3mA steady signal
	Analog Voltage	0 to 5V; 1 to 5V (default); 0 to 10V; 2 to 10V (selectable) During fault condition, 1 to 5V and 2 to 10V outputs are 0V.
	Modbus RTU over RS-485	Baud rate: 9,600 or 19,200 (default) (selectable)
		Start bits: 1
		Data bits: 8
Parity: None, Odd, Even (default) (selectable)		
Stop bits: 1 or 2 (selectable)		
Retry time: 500 ms, min time between retries		
	End of message: Silent 3.5 characters	
Power Supply and Relays	Operating voltage	19.5 to 28.5VDC; 24VAC $\pm 20\%$, 50/60 Hz
	Inrush current	1.5 A
	Operating power (max)	MRLDS-450: 4W, 170mA @ 24VDC
	Relay rating	3 SPDT 1 A at 24VAC/VDC, resistive load
	Audible alarm	Internal Buzzer ≥ 72 dB at 4" (10cm)
	Alarm delay	0 to 15 minutes (selectable)
Wiring	Power and analog signal	2-core shielded cable, 16 to 20 AWG (0.5 to 1.5mm ²)
	Modbus network	3-core, 2 twisted pair + ground, shielded cable with 120 Ω characteristic impedance, 16 to 24 AWG (0.5 to 1.5 mm ²)
	Cable gland	M20, 10-14mm cable outer diameter M16, 4-8mm cable outer diameter

Table 6-1 - General Specifications

Category	Specifications	
Physical Specifications	Enclosure protection	IP66
	Enclosure Size (W×H×D) (Approx.)	MRLDS-450 IP66: 6.5×6.5×3.4" (165×165×87mm)
	Weight (Approx.)	MRLDS-450: 1lb, 1oz (480g)
Environmental	Temperature	- 40 to 120°F (-40 to 50°C)
	Storage temperature	- 5 to 100°F (-20 to 40°C)
	Humidity	5 to 90% RH, non-condensing (15 to 90% RH, non-condensing, EC sensors excl. O ₂)
	Pressure	23.6 to 32.5 inch Hg/800 to 1,100 mbar
	Elevation	0 to 10,000 ft. (3,000 m) altitude
	Influences	For influences on the measurement performance and restrictions of a particular sensor, see sensor data sheet.
Agency Approvals	CE, EN 50270:2015, UL/CSA/IEC/EN 61010-1	

Table 6-1 - General Specifications

7 Ordering Information

Emerson P/N	IP66, 3 x Relays, Analog Output, Modbus Output, Audible & Visual Alarms	Emerson P/N	Replacement Sensor	Sensor Type
	Gas Type and Detection Range		Pre-calibrated Sensor Modules	
809-1040	CO ₂ 0-5,000ppm	809-1140	CO ₂ 0-5,000ppm	IR
809-1041	CO ₂ 0-10,000ppm	809-1141	CO ₂ 0-10,000ppm	IR
809-1047	R404A 0-1,000ppm	809-1147	R404A 0-1,000ppm	SC
809-1048	R407A 0-1,000ppm	809-1148	R407A 0-1,000ppm	SC
809-1049	R410A 0-1,000ppm	809-1149	R410A 0-1,000ppm	SC
809-1050	R22 0-1,000ppm	809-1150	R22 0-1,000ppm	SC
809-1056	R448A 0-1,000ppm	809-1156	R448A 0-1,000ppm	SC
809-1058	R513A 0-1,000ppm	809-1158	R513A 0-1,000ppm	SC
809-1066	R422D 0-1,000ppm	809-1166	R422D 0-1,000ppm	SC
809-1068	R449A 0-1,000ppm	809-1168	R449A 0-1,000ppm	SC

Table 7-1 - Part Numbers and Ordering Information

Emerson P/N	MRLDS-450 Accessories
809-1190	Calibration Adapter Kit
809-1191	Horn + strobe 24VDC; blue lens
809-1192	Horn + strobe 24VDC; amber lens
809-1193	Horn + strobe 24VDC; red lens
809-1194	Horn + strobe; blue lens; MP120K 120VAC adapter
809-1195	Horn + strobe; amber lens; MP120K 120VAC adapter
809-1196	Horn + strobe; red lens; MP120K 120VAC adapter

Table 7-2 - Accessory Part Numbers and Ordering Information



For Technical Support call 770-425-2724 or email ColdChain.TechnicalServices@Emerson.com

The contents of this publication are presented for informational purposes only and they are not to be construed as warranties or guarantees, express or implied, regarding the products or services described herein or their use or applicability. Emerson Retail Solutions, Inc. and/or its affiliates (collectively "Emerson"), reserves the right to modify the designs or specifications of such products at any time without notice. Emerson does not assume responsibility for the selection, use or maintenance of any product. Responsibility for proper selection, use and maintenance of any product remains solely with the purchaser and end-user.

Emerson is a trademark of Emerson Electric Co. ©2020 Emerson Retail Solutions, Inc. All rights reserved.