

Large ZX Condensing Unit

User Manual - Dubai Sourced Units



COPELAND™

EMERSON™

Table of contents

Introduction	2
Safety Information	3
Nomenclature	5
Operating Envelope	6
Technical data	6
Features & Benefits	8
Physical Layout	10
CoreSense Controller	15
Network Wiring	24
Electrical connection	26
Installation, System Processing and Commissioning	28
Troubleshooting	34
System Start-Up and Operational Check Sheet	45

Introduction

Thank you for purchasing Copeland Large ZX Condensing Unit for refrigeration applications. This unit comes with high efficiency Copeland™ fixed and digital scroll compressor with enhanced vapor injection technology.

This is best in class unit within the capacity and operating range available in the market.

Emerson ZX series has been highly successful in global market and enjoys proven success with its energy savings and customer friendly electronic features.

This document is designed to help the contractor and customer for the installation, commissioning & operation of Emerson's Large ZX Condensing Unit.

Disclaimer

Please read through this operation manual to familiarize yourself with the installation, commissioning, and operation of this product. Please do read the following information in this page before proceeding with the rest of the manual.

The Emerson™ Large ZX scroll refrigeration condensing units should only be installed by suitably qualified and experienced refrigeration technicians. No responsibility can be accepted for damage caused by inexperienced or inadequately trained site technicians or improper system design. All instructions and procedures described in this manual are based on good refrigeration trade practices as applicable to this particular product. The installation contractor may prefer to use variations to these recommendations. However, the methods described in this manual represent the minimum requirements to avoid any subsequent warranty claims for this equipment and its components. These instructions do not cover the fundamentals of good electrical or refrigeration practice and are therefore intended for use only by qualified and/or experienced personnel or technicians.







For any additional query, please consult your local sales office, quoting unit model and serial number as shown on the nameplate. In case of ambiguity, the wiring diagram supplied with each unit takes precedence over the diagram in this manual.

1. Safety Information

1.1 Installation and commissioning work on CDU shall be carried out only by qualified, refrigeration personnel who have been trained and instructed.

1.2 Large ZX condensing unit is manufactured according to the latest safety standards. Emphasis has been placed on the user's safety. For relevant standards please refer to the manufacturer's declaration, available on request. You are strongly advised to follow these safety instructions.

1.3 Icon explanation

 <p>WARNING This icon indicates instructions to avoid personal injury and material damage.</p>	 <p>CAUTION This icon indicates instructions to avoid property damage and possible personal injury.</p>
 <p>High voltage This icon indicates operations with a danger of electric shock.</p>	 <p>IMPORTANT This icon indicates instructions to avoid malfunction of the compressor.</p>
 <p>Danger of burning or frostbite This icon indicates operations with a danger of burning or frostbite.</p>	<p>NOTE This word indicates a recommendation for easier operation.</p>
 <p>Explosion hazard This icon indicates operations with a danger of explosion.</p>	

1.4 Safety Statements

- Only qualified and authorized refrigeration personnel are permitted to install, commission and maintain this equipment.
- Electrical connections must be made by qualified electrical personnel.
- All valid standards for connecting electrical and refrigeration equipment must be observed.
- The national legislation and regulations regarding personnel protection must be observed.



Use personal safety equipment. Safety goggles, gloves, protective clothing, safety boots and hard hats should be worn where necessary.

1.5 General Instructions



Warning

System breakdown! Personal injuries! Never install a system in the field and leave it unattended when it has no charge, a holding charge, or with the service valves closed without electrically locking out the system.

System breakdown! Personal injuries! Only approved refrigerants and refrigeration oils must be used.



Warning

High shell temperature! Burning! Do not touch the compressor until it has cooled down. Ensure that other materials in the area of the compressor do not get in touch with it. Lock and mark accessible sections.



Caution

Overheating! Bearing damage! Do not operate compressors without refrigerant charge or without being connected to the system.



Caution

Compressors contain oil & refrigerant under pressure. Release pressure from both high & low side of compressor before servicing.



Caution

Tube brazing & compressor operation can produce hot surfaces. To avoid burns, allow surfaces to cool.

1.6 Safety Refrigerants/Lubricant

- a. Please use correct refrigerant as designed to work in safe operating envelope.
- b. Compressor is supplied with an initial oil charge. The standard oil charge for use with HFC refrigerant is polyol ester (POE) lubricant Emkarate RL 32 3MAF.

1.7 Receiving your unit

All units are filled with dry nitrogen at a positive pressure before transportation. When you receive the unit from Emerson or an authorized representative, it is important to check the pressure of each unit. If the unit found to be without any pressure on receipt, please contact Emerson or their authorized distributor. Damage to the unit caused by the transportation / handling should fall within the category of insurance claims and not be a manufacturing defect. It is also advisable to inspect the rest of the unit for any physical damage and inform Emerson or authorized distributor.

2. Nomenclature

ZX	D	120	B	E	TFM	523
Condensing unit family	D= Digital medium temp LD= Digital low temp	12-20HP	Generation	E= Ester oil	TFM= 380V/420V-3ph-50 HZ	BOM

3. Scope of Supply

BOM	ZXD 12 to 20 HP	ZXLD 12 to 20 HP
	523	523
Liquid Line Filter Drier		
Moisture Indicator		
Oil Separator		
Oil Reservoir		
Combination Oil Separator / Reservoir		
Accumulator		
LP Transducer		
HP Transducer		
Fixed LP Safety Switch		
Adjustable LP Safety Switch		
Service Junction Box		
CoreSense Protection		
Digital Modulation		
Intelligent Store Ready		
Fan Speed Controller		
Circuit Breaker		
Compressor Sound Jacket		
Receiver Certification (UL/PED)		
Pressure Relief Valve		
HP/LP Pressure Gauge		

4. Operating Envelope

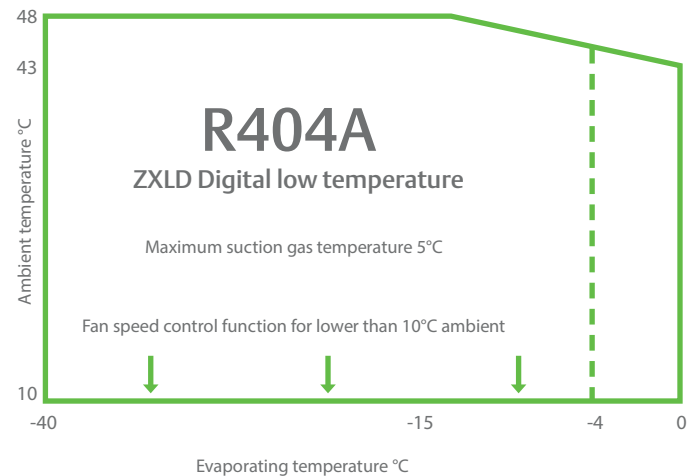
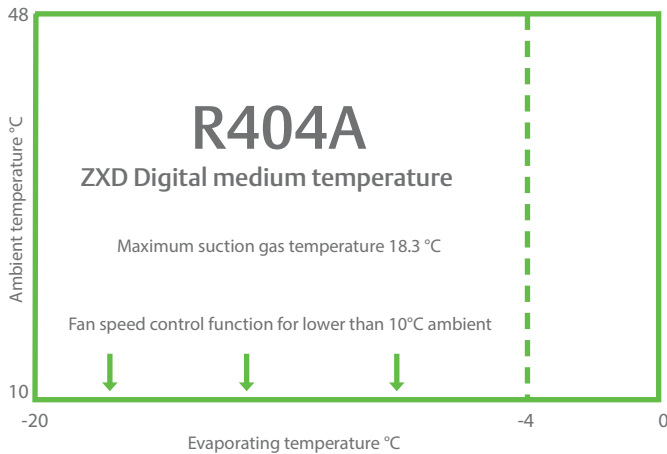

Note: ZXD120/160BE maximum evaporating temperature is 0 °C;
ZXD200BE maximum evaporating temperature is -4°C

Note: ZXLD120BE maximum evaporating temperature is 0 °C;
ZXLD160/200BE maximum evaporating temperature is -4°C

5. Models

Technical Data: 12 HP

Model Name			ZXD120BE-TFM	ZXLD120BE-TFM	
Nominal HP			12		
Power Supply	Compressor		3PH-380V/ 420V-50Hz	3PH-380V/ 420V-50Hz	
	Fan Motor		1PH-220V-50Hz	1PH-220V-50Hz	
Performance	ET/AT/RGT	°C	-0.011441257	-0.2	
	R404A	Capacity	kW	24.22	11.76
		COP	kW	2.41	1.3
	Sound Pressure Level @1m	dB(A)	65	69	
Compressor	Model name		ZX45KCE-TFD-558 ZBD45KQE-TFD-538	ZX118KCE-TFD-557 ZXJ18KCE-TFD-557	
	Rated Load Ampere	A	9.6 + 10.1	11.1+ 11.1	
	Locked Rotor Ampere	A	74	74	
	Oil Type		POE	POE	
	Oil Charge	L	1.9 + 1.8	1.9 + 1.9	
Fan Motor	Number of Fan		2	2	
	Diameter	mm	600	600	
	Fan Speed	rpm	930	930	
	Air Flow	m ³ /h	13940	13940	
	Total Fan Motor Power	W	700	700	
Others	Oil Separator / Reservoir Charge	L	0.6/4	0.6/ 4	
	Receiver Volume	L	17	17	
	Suction Pipe OD	inch	1 3/8"	1 3/8"	
	Liquid Pipe OD	inch	3/4"	3/4"	
	Dimension (W x D X H)	mm	1645*1010*1066	1645*1010*1066	
	Weight(Net)	kg	357kg	362kg	
	WeightGross)	kg	457kg	462kg	

Technical Data: 16 HP

Model Name			ZXD160BE-TFM	ZXLD160BE-TFM
Nominal HP			16	
Power Supply	Compressor		3PH-380V/ 420V-50Hz	3PH-380V/ 420V-50Hz
	Fan Motor		1PH-220V-50Hz	1PH-220V-50Hz
Performance	ET/AT/RGT	°C	-0.011441257	-0.2
R404A	Capacity	kW	29	15.5
	COP	kW	2.4	1.32
	Sound Pressure Level @1m	dB(A)	69	69
Compressor	Model name		ZXD61KVE-TFD	ZXJ25KCE-TFD
			ZX61KVE-TFD	ZXI25KCE-TFD
	Rated Load Ampere	A	11.1 + 11.1	14.6 + 14.6
	Locked Rotor Ampere	A	74	102
	Oil Type		POE	POE
	Oil Charge	L	1.9 + 1.9	1.9 + 1.9
Fan Motor	Number of Fan		2	2
	Diameter	mm	600	600
	Fan Speed	rpm	930	930
	Air Flow	m ³ /h	13940	13940
	Total Fan Motor Power	W	700	700
Others	Oil Separator/ Reservoir Charge	L	0.6/4	0.6/ 4
	Receiver Volume	L	21.6	21.6
	Suction Pipe OD	inch	1 3/8"	1 3/8"
	Liquid Pipe OD	inch	3/4"	3/4"
	Dimension (W x D X H)	mm	1645*1010*1066	1645*1010*1066
	Weight(Net)	kg	362kg	362kg
	Weight(Gross)	kg	462kg	462kg

Technical Data: 20 HP

Model Name			ZXD200BE-TFM	ZXLD200BE-TFM
Nominal HP			20	
Power Supply	Compressor		3PH-380V/ 420V-50Hz	3PH-380V/ 420V-50Hz
	Fan Motor		1PH-220V-50Hz	1PH-220V-50Hz
Performance	ET/AT/RGT	°C	-0.011441257	-0.2
R404A	Capacity	kW	37.3	17.41
	COP	kW	2.31	1.43
	Sound Pressure Level @1m	dB(A)	69	69
Compressor	Model name		ZXD78KVE-TFD	ZXJ25KCE-TFD
			ZX78KVE-TFD	ZXI28KCE-TFD
	Rated Load Ampere	A	14.6+14.6	14.6+14.6
	Locked Rotor Ampere	A	102	121
	Oil Type		POE	POE
	Oil Charge	L	1.9+1.9	1.9+1.10
Fan Motor	Number of Fan		2	2
	Diameter	mm	630	630
	Fan Speed	rpm	920	920
	Air Flow	m ³ /h	16410	16410
	Total Fan Motor Power	W	960	960
Others	Oil Separator/ Reservoir Charge	L	0.6/ 4	0.6/ 4
	Receiver Volume	L	21.6	21.6
	Suction Pipe OD	inch	1 3/8"	1 3/8"
	Liquid Pipe OD	inch	3/4"	3/4"
	Dimension (W x D X H)	mm	1645*1010*1235	1645*1010*1235
	Weight(Net)	kg	362 kg	362 kg
	Weight(Gross)	kg	462 kg	462 kg

6. Features & Benefits

Large ZX platform condensing units were designed based on three factors demanded by industry users:

Intelligent Store™ solutions - A most innovative approach to enterprise facility management, Emerson Intelligent Store architecture integrates hardware and services, to provide retailers a single view into their entire work of facilities and understand what facilities actually cost to operate and maintain.

The Intelligent Store architecture transforms data from store equipment and controls into actionable insights.

Designed to deliver value in both new and existing stores, Emerson aims to help the retailers:

- Make better decisions on resources investment for greatest impact
- Gain accurate feedback and customized service to your specific needs
- Reduce operational costs and boost the profitability at most convenience

Energy efficiency - Utilizing Copeland™ scroll compressor technology, variable speed fan motor, large capacity condenser coil and advanced control algorithms, energy consumption is significantly reduced. End-users can save more than 20% on annual energy costs compared to equivalent reciprocating units.

Reliability - Combining the proven reliability of Copeland scroll compressors with advanced electronics controller and diagnostics, equipment reliability is greatly enhanced. Fault code alerts and fault code retrieval capabilities provide information to help improve speed and accuracy of system diagnostics. Integrated electronics provide protection against over-current, over-heating, incorrect phase rotation, compressor cycling, high pressure resets, low pressure cut-outs. It can also send out a warning message to an operator when there is liquid flood back, which can prevent critical damage on the unit.



Condensing Unit Features:

Copeland™ scroll compressor technology

Highly efficient, ultra-quiet and highly reliable.

Configured with CoreSense controller

- Provides electronic diagnosis, protection, and communication modules for energy-saving and reliable unit control.
- Provides digital modulation control.

Emerson unique digital technology

- Proven reliable modulation technology for end user energy saving, accurate temperature control and best food safety.

Enhanced vapor injection

- Vapor injection provide high efficiency for refrigeration application
- Well-tuned electronics algorithm with one big PHE to sub-cool the liquid temperature, and feed gas into the compressors' EVI ports.

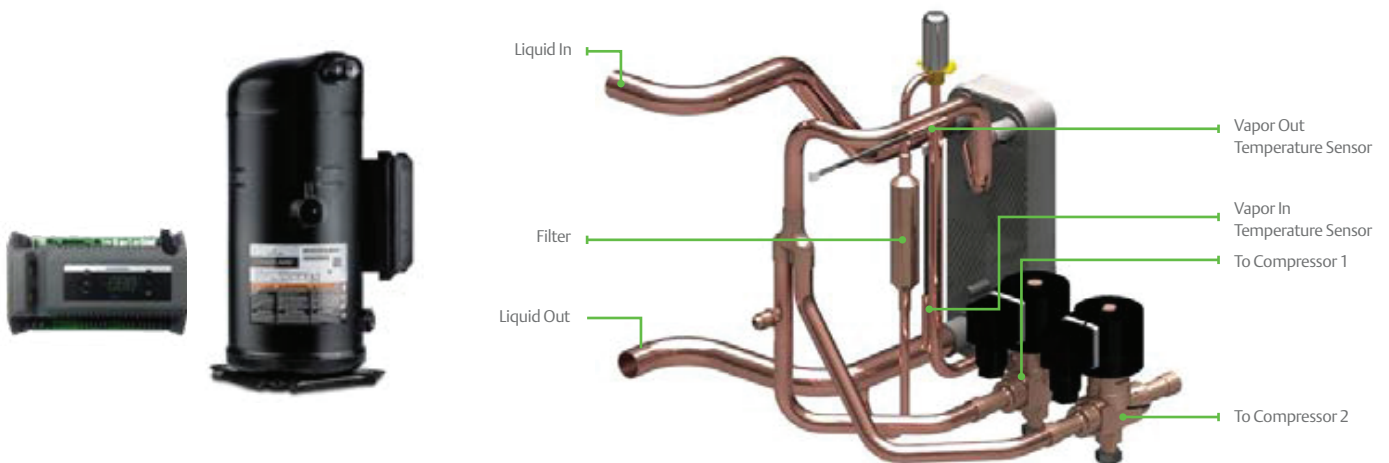

Design Features:

- Real-Time monitoring of compressor operating conditions
- Compressor reverse rotation protection
- Compressor over current protection
- Compressor internal motor protector
- Discharge gas overheat protection
- Over voltage protection
- Under voltage protection
- High pressure protection
- Low pressure protection
- Refrigerant flood back warning
- Compressor minimum off time
- Compressor oil level protection
- Intelligent store Solution: Communication and retail store monitoring

7. Physical Layout of Unit

12/16 HP

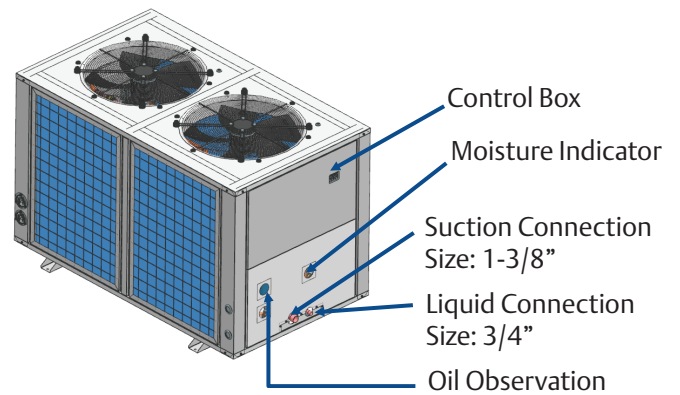
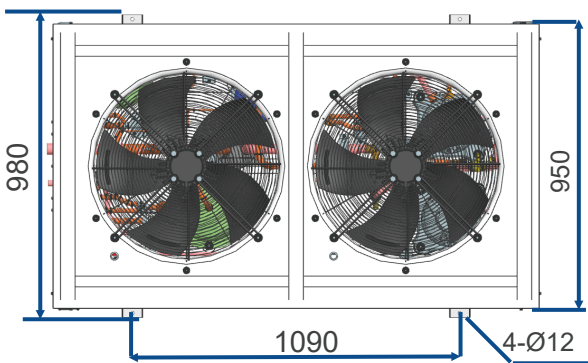
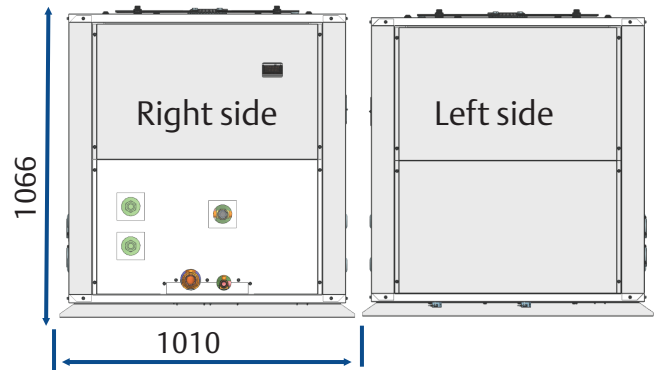
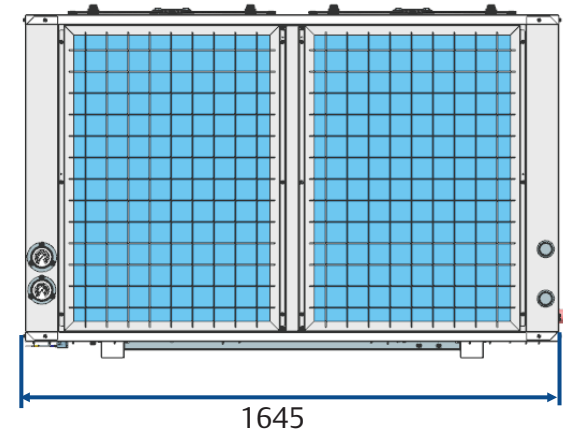

20 HP

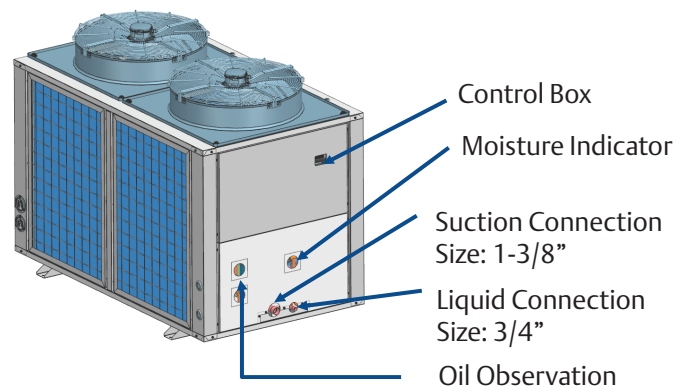
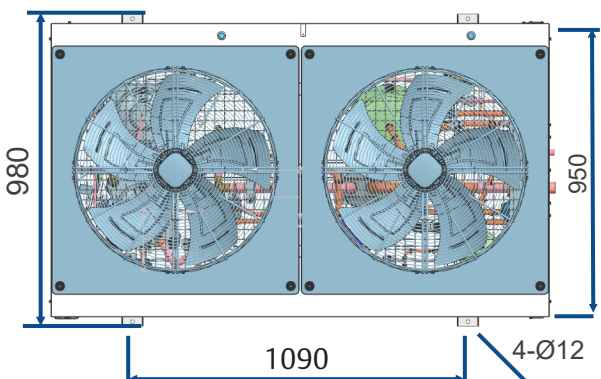
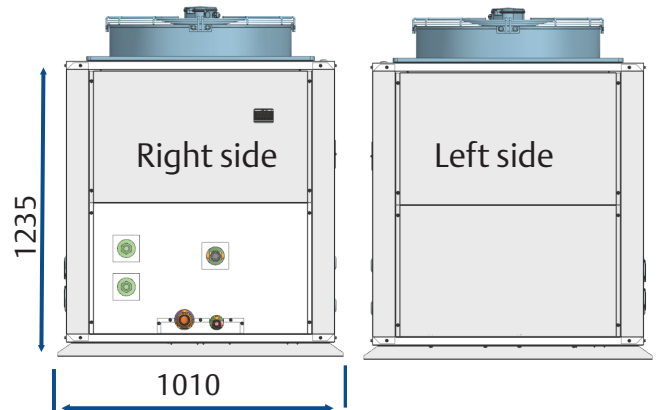
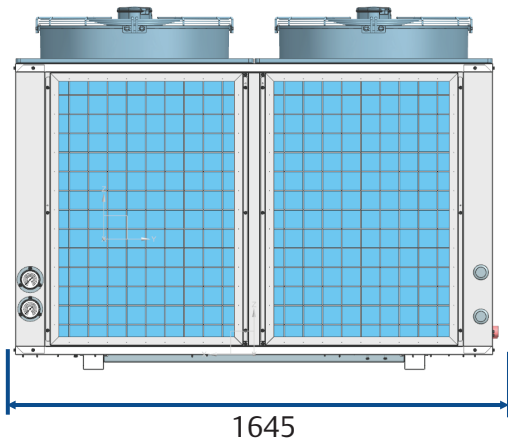

Weight

12/16/20 HP



Max Net Weight: 362 Kg

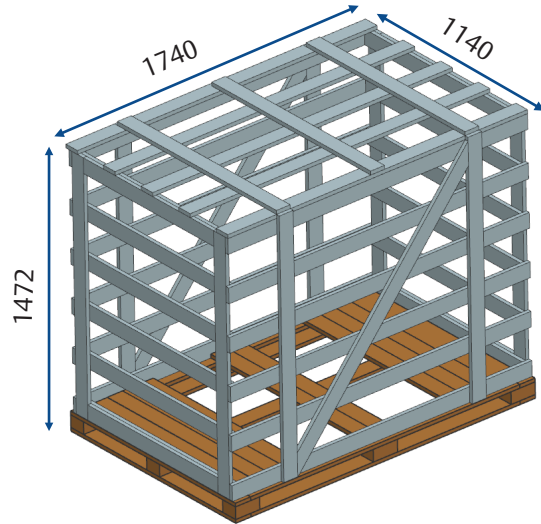

Max Gross Weight: 462 Kg

Layout

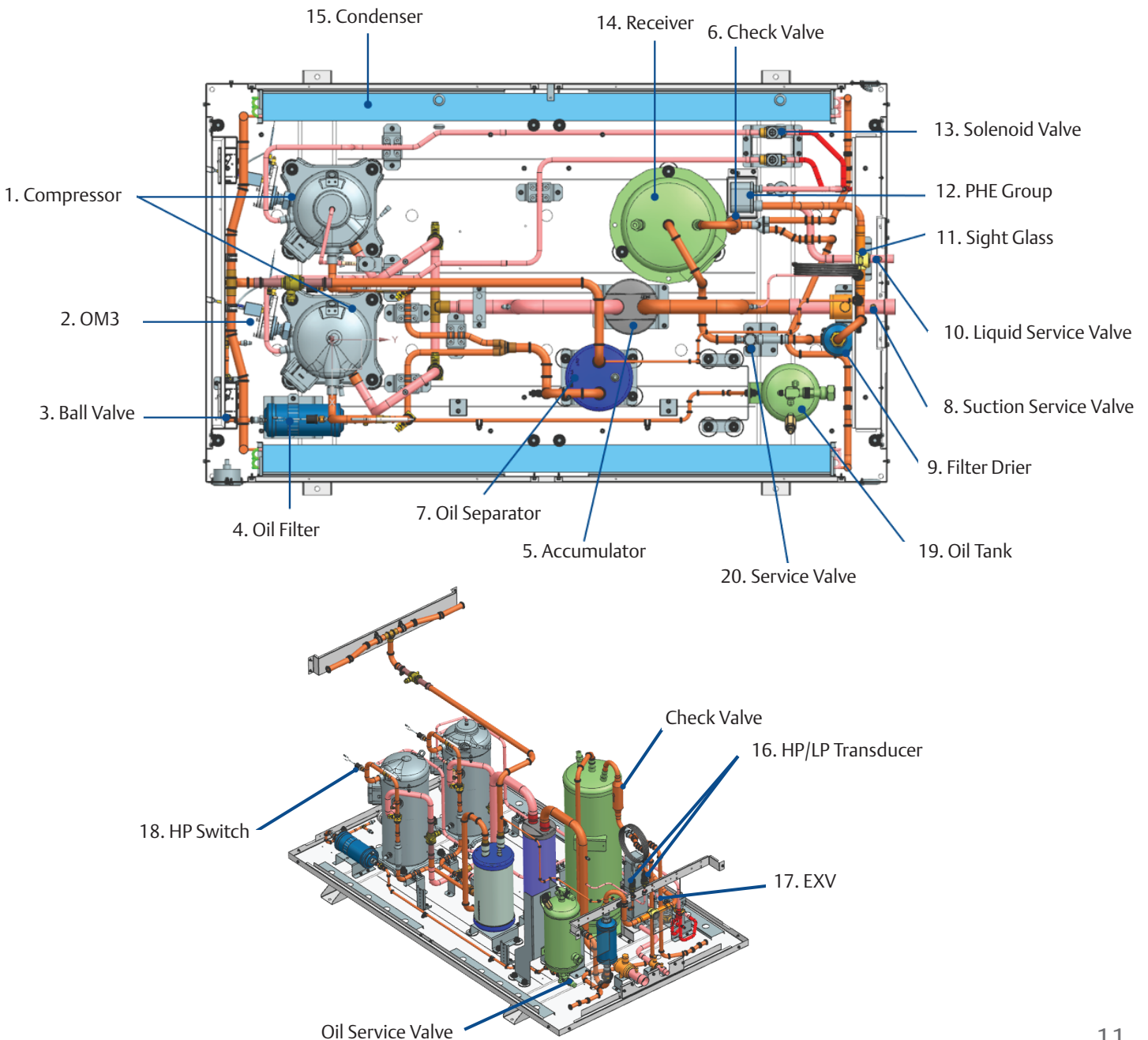

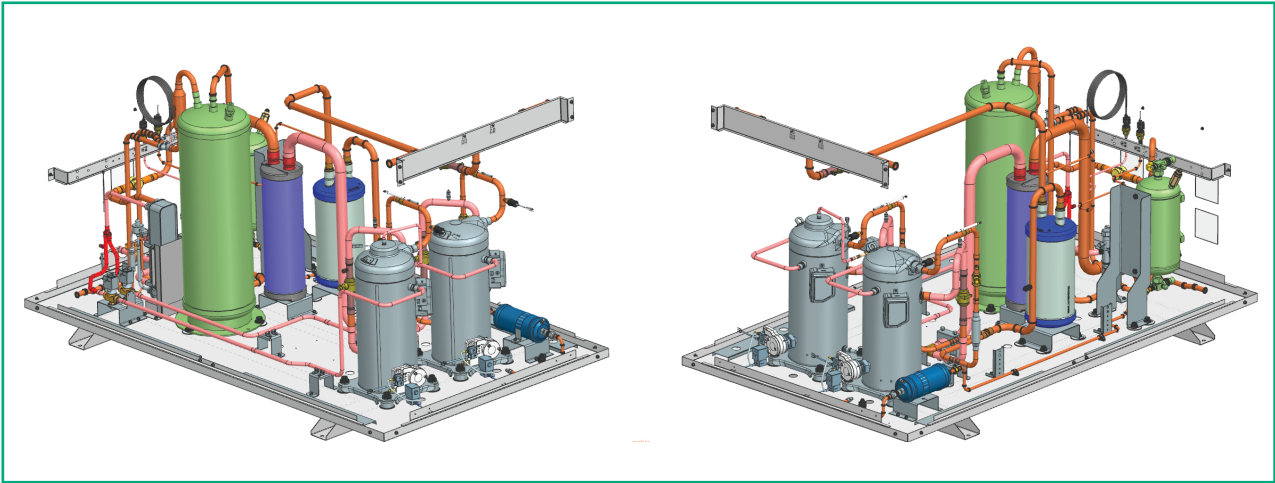

Control Box Layout

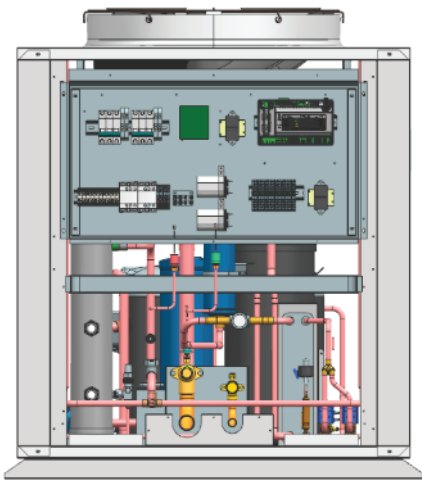

Breaker 1 & Contactor 1 are for Digital Compressor
Breaker 2 & Contactor 2 are for Fixed Compressor

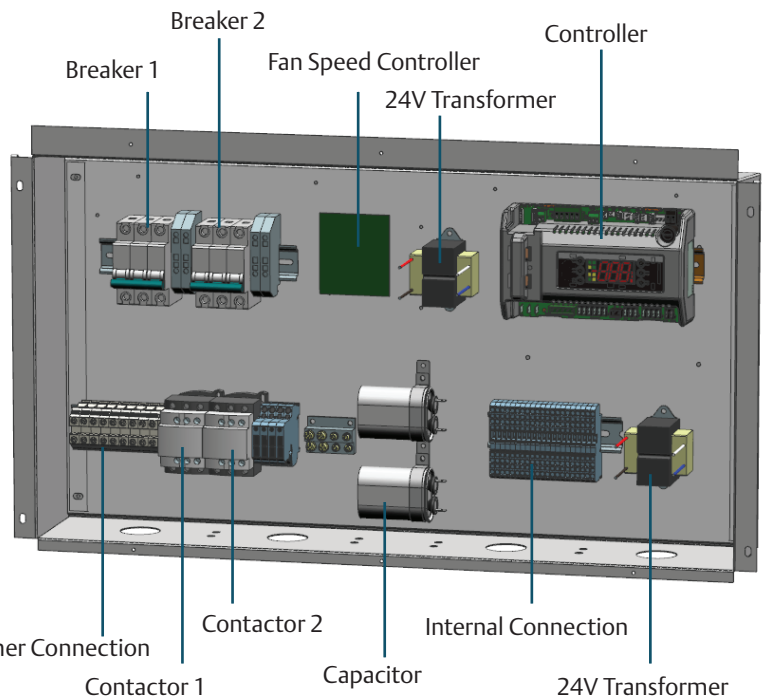

Design for Service

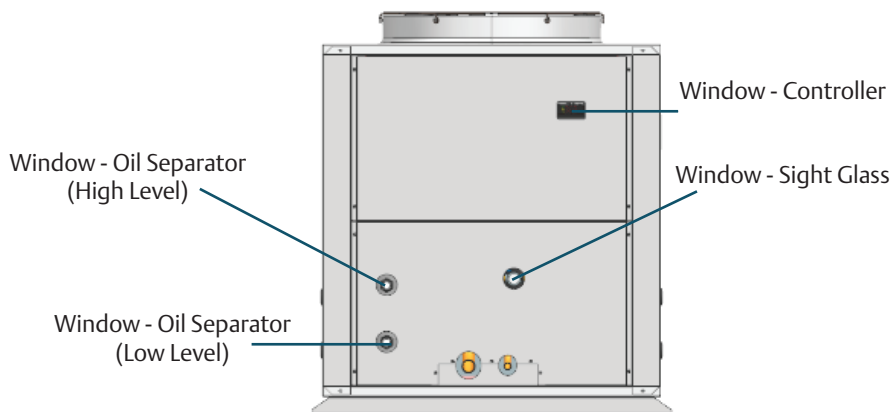

Window - Controller

- Evaporating Temperature
- Message: Alarm & Warning

Window - Oil Reservoir

- Ideal oil level should be higher than low level and lower than high level
- **Add oil immediately if oil level is lower than low level**
- Continue to run and keep watching oil level if oil level is higher than high level

Vacuum and Refrigerant Charge

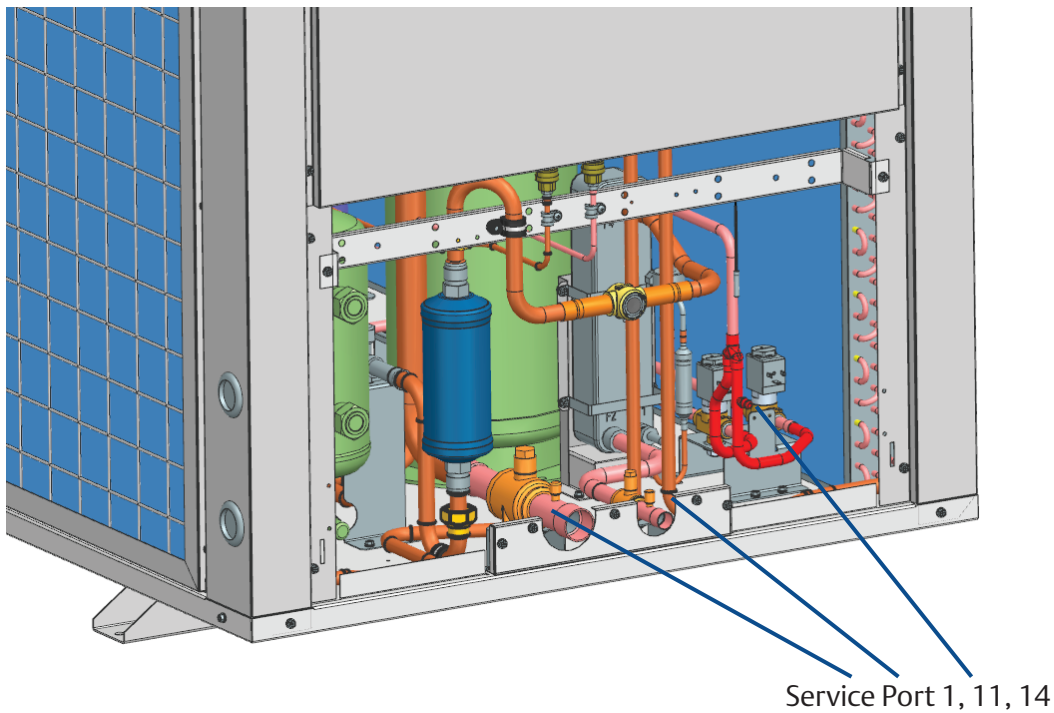

Vacuum

- Keep all the valves open
- Vacuum from service port 1, 11, 14

Refrigerant Charge

- Charge liquid refrigerant on the high side of the system
- Continue to charge controlled liquid refrigerant from suction service valve after switching on the compressor
- For the unit which has vapor injection, it is necessary to charge 0.5kg-1.0kg more after clear sight glass

Compressor Replacement

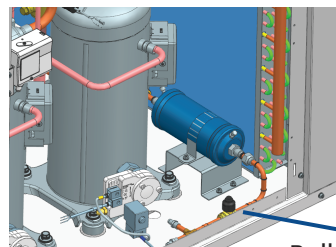
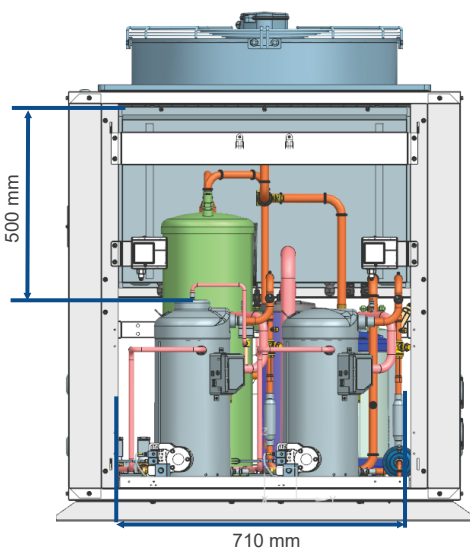

Ball Valve

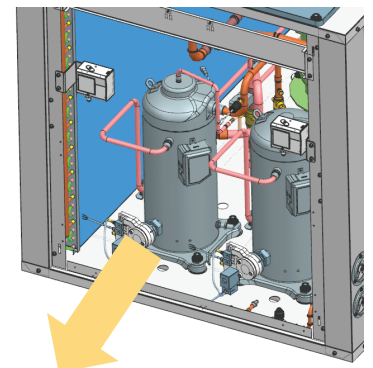

- Disconnect power supply to the unit / disconnect cables to compressor & om3 / use compressor isolation valves and oil ball valve
- De-braze the tubes off (3 locations)
- Unfasten compressor's mounting bolt
- Remove the compressor out

Oil Filter Replacement

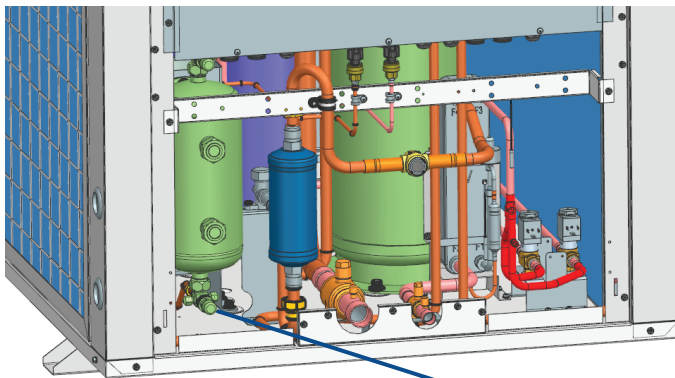

Service Valve
on Oil Reservoir

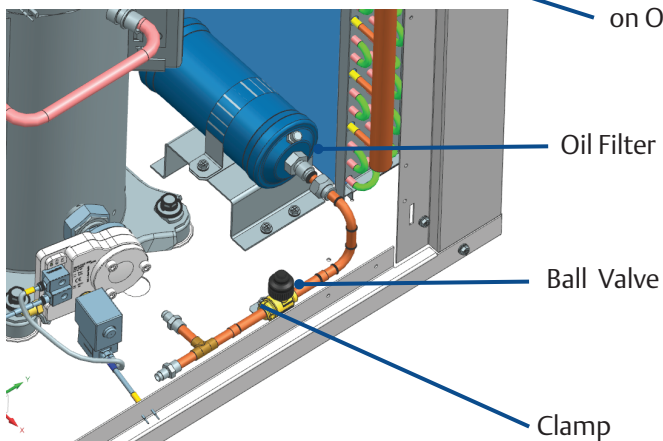
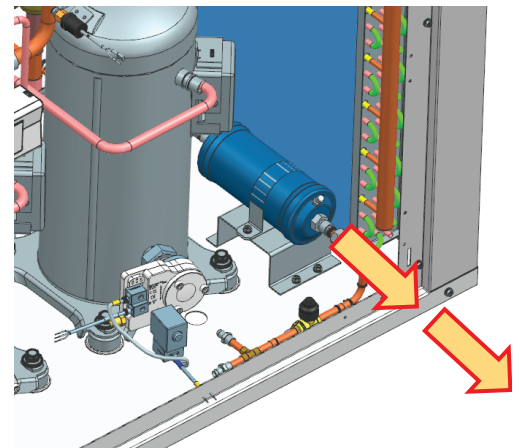

- Close valve 16 and 8.
- Disconnect tube connection at two ends
- Unfasten clamp of oil filter
- Remove the oil filter out

8. CoreSense Controller



LED descriptions

LED	Status	Description
	On	Compressor 1 is running
	Flashing	Compressor 1 is ready to start
	On	Compressor 2 is running
	Flashing	Compressor 2 is ready to start
	On	Condensing fan is running
	On	Digital compressor is unloading
	On	Display with C
	Flashing	Programmable mode

LED	Status	Description
	On	Browsing the service menu
	Flashing	Browsing the fast access menu
	On	A new alarm happened
	Flashing	Browsing the alarm menu
	On	An alarm is occurring
	On	Liquid line solenoid valve on
	-	Reserved



Keyboard descriptions - Single button

	Set	Displays target set point; In programming mode, select a parameter or confirm an operation.
	Reset	Hold for 5 seconds to reset any lockouts if the current state of the controller allow for it to be reset.
	Up	Enter the fast access menu; In programming mode, browse the parameter codes or increases the displayed value.
	Down	In programming mode it browses the parameter code or decreases the displayed value
	Service	Enter the service and alarm menu.
	Defrost	Hold for 3 seconds to start a manual defrost or terminate an active defrost (Not available at the moment).







Keyboard descriptions - Combined buttons

	Press and hold for about 3 seconds to lock (Pon) or unlock (Pof) the keyboard.
	Pressed together to exit programming mode or menu; under rtC and PAr, this combination allows the user to go back to previous level.
	Pressed together for 3 seconds allows access to first level of programming mode.
	Pressed together for 3 seconds allows access to EXV manual setting.



Controller display upon start-up

Step	Action	Phenomenon and description
1	Power on controller	All LEDs will light up for 3 seconds.
2		Firmware version will be displayed for 3 seconds.
3		Parameter setting file (bin file) identifier will be displayed for 3 seconds.
4		Normal display (actual suction temperature will be displayed)









RTC (Real Time Clock) setting

Step	Action	Phenomenon and description
1	Press "SET" + 	Enter menu to select
2	Press  + 	Select rtC
3	Press "SET"	n01, minute n02, hour n03, day n04, month n05, year (last two digits)
4	Press "SET"	Display actual value
5	Press  + 	Modify the value
6	Press "SET"	Press SET: the value will flash for 3 seconds, then move to the next value
7	Press "SET" + 	Exit to rtC
8	Press "SET" + 	Exit to main menu (or wait for 120 seconds and exit automatically)

Evaporating temperature

Step	Action	Phenomenon and description
1	Press " SET " > 3 seconds	Press SET button for more than 3 seconds, the measurement units (°C) will flash together
2	Press "  " or "  "	Modify the number for target evaporating temperature
3	Press " SET "	Press SET to confirm, the number wil flash for 2 seconds (or wait for about 10 seconds to confirm)

Refrigerants

Step	Action	Phenomenon and description
1	Press " SET " + "  "	Enter menu to select PAr (parameter) or rtC
2	Press "  " + "  "	Select PAr (parameter)
3	Press " SET "	Confirm selection
4	Press "  " or "  "	Browse to parameter C07
5	Press " SET "	Confirm selection
6	Press "  " or "  "	Select refrigerant to be used
7	Press " SET "	The number will flash for 3 seconds and confirm the refrigerant selection
8	Press "  " or "  "	Exit (or exit automatically after waiting for 120 seconds)

Replacing controller









After a new controller is replaced and initial power is on, it is critical to reset parameters defined on the label below the nameplate on the unit panel. Here is an example of a label:

Controller Parameter Default Setting		
MODEL		
Parameter	Description	Default Value
H07	Digital Compressor MCC	
H09	Digital Compressor Current Protection	
H27	Fixed Compressor MCC	
H28	Fixed Compressor Current Protection	
H13	MIN. Operating Voltage	
H14	MAX. Operating Voltage	
C07*	Refrigerant	
Notes:*Ensure that parameter C07 is set to match the actual refrigerant used. If not, set C07 following label "Unit Operation Setting After Installation".		

















Notes: C07 is accessible in Pr1 parameter, and the other parameters are accessible in Pr2 parameter

The step-by-step procedure to access and modify the Pr1 and Pr2 parameters are outlined below:





Pr1 parameter (1st level) browse and modification

Step	Action	Phenomenon and description
1	Press " SET " + 	Enter menu to select
2	Press  	Select PAr (parameter)
3	Press " SET "	Confirm, select, and browse Pr1 parameters
4	Press  	Browse to Pr1 parameters
5	Press " SET "	View the actual number of the Pr1 parameters
6	Press  	Modify the actual number of the Pr1 parameters
7	Press " SET "	Press SET: the number will flash for 3 seconds and confirm the modifications; Will go to the next Pr1 parameter
8	Press " SET " + 	Exit (or exit automatically after waiting for 120 seconds)



Pr2 parameter (2nd level) browse and modification

Step	Action	Phenomenon and description
1	Press "SET" + "  >3 seconds	Enter Menu to select PAr (parameter) or rtC, enter into parameter browse & setting mode.
2	Press "  or " 	Select PAr (parameter)
3	Press "SET"	Confirm above selection & display Pr1 level parameters
4	Press "  or " 	Find parameter "t18"
5	Press "SET"	"PAS" will flash for 3 times, then display "0--", "0" flashes (Prompt to enter pass code "321")
6	Press "  or " 	Change value to "3"
7	Press "SET"	Display "30-", "0" flashes
8	Press "  or " 	Change value to "2"
9	Press "SET"	Display "320", "0" flashes
10	Press "  or " 	Change value to "1"
11	Press "SET"	Confirm password & enter into Pr2 level parameter
12	Press "  or " 	Browse detailed Pr2 level parameter name
13	Press "SET"	View current parameter setting values
14	Press "  or " 	Change parameter setting values
15	Press "SET"	Confirm the changes, changed values flash for 3 times, then display next parameter name
16	Press "SET" + " 	Display "Par", exit parameter browse & setting mode.
17	Press "SET" + " 	Exit to main menu





Access alarm code (Maximum of 50 record)

Step	Action	Phenomenon and description
1	Press "  "	Display SEC
2	Press " SET "	Display A01
3	Press "  "	Display alarm code in A01
4	Press "  "	Display A02
5	Press "  "	Display alarm code in A02
6
7	Press " SET " + "  "	Exit (or exit automatically after waiting for 15 seconds)

Quick access menu browse - Sensor status and actual values

Step	Action	Phenomenon and description	
1	Press " 	Enter quick access menu, will display P1P (Press Up or Down to view other sensors)	
2	Press " SET "	View the actual value of P1P	
3	Press " SET "	Change to next sensor code	
4	Press " SET " + " 	Exit (or exit automatically after waiting for 60 seconds)	
<p>Sensor code and values descriptions (nP, noP, or nA means that the sensor does not exist; Err means that the sensor fails, out of range, disconnected, or does not configure properly)</p>		P1P	Suction pressure sensor
		P2P	Condensing pressure sensor
		P2t	Mid-coil temperature sensor
		P3t	Digital compressor discharge line temperature sensor
		P4t	PHE vapor inlet temperature sensor
		P5t	PHE vapor outlet temperature sensor
		P6t	Ambient temperature sensor
		P7t	ON-OFF compressor discharge line temperature sensor
		5H	PHE superheat
		oPP	EXV opening percentage
		LL5	Solenoid valve status (not used)
		Std	Condensing temperature set point
		Aoo	Fan's analog output signal percentage
		dso	Percentage of PWM output driving the valve of the Digital Scroll compressor
		Lt	Minimum cold room temperature (unused)
		Ht	Maximum cold room temperature (unused)
		tU1	#1 voltage sensor
		tU2	#2 voltage sensor
		tU3	#3 voltage sensor
		tA`	#1 current sensor
TA2	#2 current sensor		
Hm	Time menu		

Exact timing of the alarm

Step	Action	Phenomenon and description
1	Press "  "	Display SEC
2	Press " SET "	Display A01
3	Press "  "	Display alarm code in A01
4	Press " SET "	Display Hr
5	Press "  "	Display the alarm exact timing: hour
6	Press "  "	Display Min
7	Press "  "	Display the alarm exact timing: minute
8	Press "  "	Display dAy
9	Press "  "	Display the alarm exact timing: day
10	Press "  "	Display Mon
11	Press "  "	Display the alarm exact timing: month
12	Press "  "	Display yEA
13	Press "  "	Display the alarm exact timing: year
14	Press " SET " + "  "	Exit (or exit automatically after waiting for 15 seconds)

Upload the program from the controller to Hot-Key

Step	Action	Phenomenon and description
1	Insert Hot-key when the controller is on	
2	Press "  "	The uPL message will appear followed by a flashing End label (Note: If Err is displayed, it means it failed to upload the program to hot-key. Please restart the process.)
3	Press " SET "	End will stop flashing
4	Turn off the controller and remove the Hot-key	
5	Turn on the controller	

Download the program from Hot-key to controller

Step	Action	Phenomenon and description
1	Turn off the controller	
2	Insert Hot-key	
3	Turn on the controller	The doL message will blink followed by a flashing End label (Note: If Err is displayed, it means it failed to download the program to Hot-key. Please restart the process.)
4		Controller will restart working with the new parameters after 10 seconds
5	Remove Hot-key	

9. Network wiring

Dixell XWEB serial address

- Connect to the ModBUS network using cable with shielded wires, minimum section 0.75mm² (e.g. BELDEN8761).
- Do not connect shield to ground.
- Do not connect the "Gnd" terminal.
- Remember to draw a map of the line. This will help you to find an error if something is wrong.
- RS485 devices are polarity sensitive.



Figure 9. Correct network wiring



Figure 10. Incorrect network wiring

Dixell XWEB Configuration

XWEB is compatible with CDU/Rack if XWEB has the library of Large ZX and EMP Rack CoreSense controller.

Termination resistor for XWEB

If XWEB is placed at the beginning or end of the line, please install its termination resistor by adding a jumper in position 2 (JMP2 on the back side of the unit). Do not add the jumper if XWEB is placed in the middle of the RS485 line.

Large ZX CDU connected to XWEB

Large ZX CDU connected to the Dixell XWEB with the Intelligent Store Solution module using RS485 Modbus.

Connect the ZX CDU to the ModBUS network as shown on figure 11.

Connect the network cable to the three-terminal connector on the XWEB port that has been configured as ModBus port (COM 12, 13, 14).

Connect port "13" of XWEB to port "D0485 +" of CoreSense and port "12" of XWEB to port "D1485 -" of CoreSense for RS485 communication.

Refer to XWEB application manual for the setting of XWEB.

10. Electrical Connections

ZXD/ZXLD Condensing Unit Wiring Diagram TFM : 380/420V, 50Hz, 3Ph + N

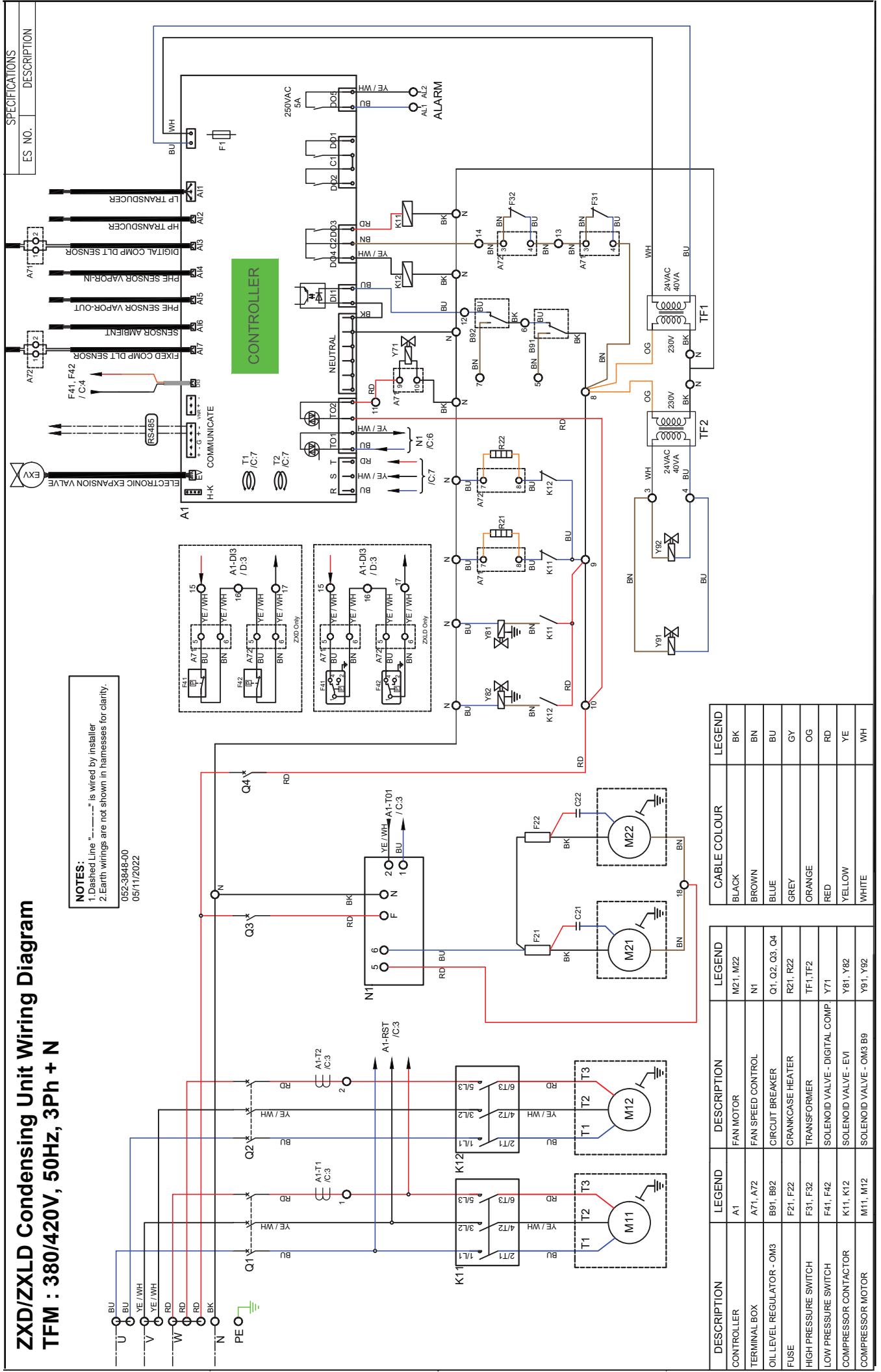

NOTES:
 1. Dashed Line "-----" is wired by installer.
 2. Earth wirings are not shown in harnesses for clarity.

052-3848-00
05/11/2022

SPECIFICATIONS	
ES. NO.	DESCRIPTION

DESCRIPTION	LEGEND	DESCRIPTION	LEGEND	CABLE COLOUR	LEGEND
CONTROLLER	A1	FAN MOTOR	M21, M22	BLACK	BK
TERMINAL BOX	A71, A72	FAN SPEED CONTROL	N1	BROWN	BN
OIL LEVEL REGULATOR - OM3	B91, B92	CIRCUIT BREAKER	Q1, Q2, Q3, Q4	BLUE	BU
FUSE	F21, F22	CRANKCASE HEATER	R21, R22	GREY	GY
HIGH PRESSURE SWITCH	F31, F32	TRANSFORMER	TF1, TF2	ORANGE	OG
LOW PRESSURE SWITCH	F41, F42	SOLENOID VALVE - DIGITAL COMP.	Y1	RED	RD
COMPRESSOR CONTACTOR	K11, K12	SOLENOID VALVE - EVI	Y81, Y82	YELLOW	YE
COMPRESSOR MOTOR	M11, M12	SOLENOID VALVE - OM3 B9	Y91, Y92	WHITE	WH

ZXD120 Condensing Unit Wiring Diagram

TFM : 380/420V, 50Hz, 3Ph + N

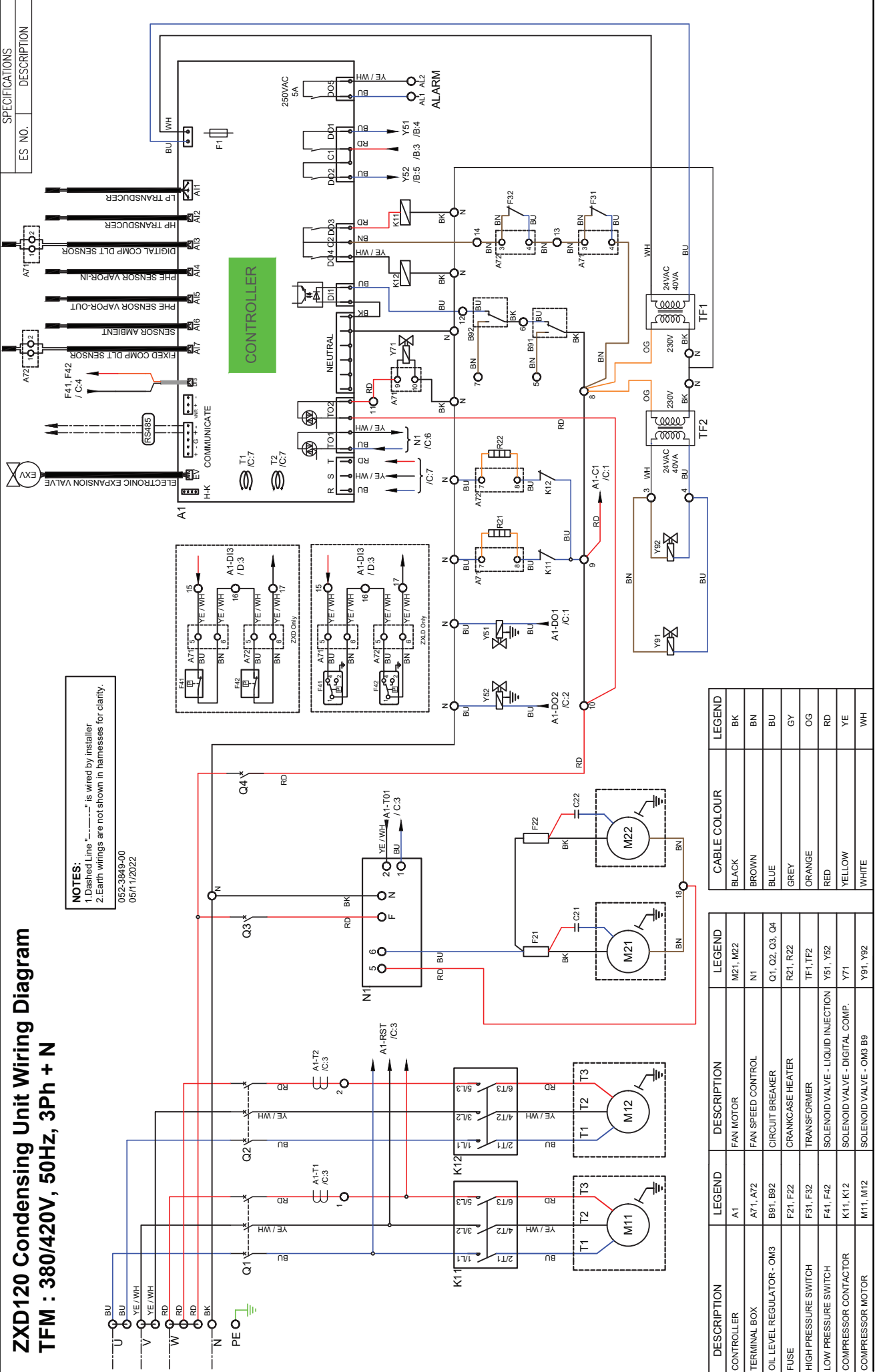

NOTES:
 1. Dashed Line "....." is wired by installer
 2. Earth wirings are not shown in harnesses for clarity.
 052-3849-00
 05/11/2022

ES NO.	DESCRIPTION
--------	-------------

CABLE COLOUR	LEGEND
BLACK	BK
BROWN	BN
BLUE	BU
GREY	GY
ORANGE	OG
RED	RD
YELLOW	YE
WHITE	WH

DESCRIPTION	LEGEND	DESCRIPTION	LEGEND
CONTROLLER	A1	FAN MOTOR	M21, M22
TERMINAL BOX	A71, A72	FAN SPEED CONTROL	N1
OIL LEVEL REGULATOR - OM3	B91, B92	CIRCUIT BREAKER	Q1, Q2, Q3, Q4
FUSE	F21, F22	CRANKCASE HEATER	R21, R22
HIGH PRESSURE SWITCH	F31, F32	TRANSFORMER	TF1, TF2
LOW PRESSURE SWITCH	F41, F42	SOLENOID VALVE - LIQUID INJECTION	Y51, Y52
COMPRESSOR CONTACTOR	K11, K12	SOLENOID VALVE - DIGITAL COMP.	Y71
COMPRESSOR MOTOR	M11, M12	SOLENOID VALVE - OM3 B9	Y91, Y92

11. Installation, System Processing and Commissioning

Utmost care must be taken while handling the Large ZX condensing unit. Please go through the contents below to ensure proper handling.

a. Location and Fixing

Large ZX should always be installed in a location that ensures clean air flow. The minimum operating space for unit is described in below figure. Both service access and airflow have been considered in making these recommendations. Where multiple units are to be installed in the same location, the contractor needs to consider each individual case carefully. There can be many variations of unit quantities and available space and it is not the intention of this manual to go over these. Ideally, the unit should be mounted on a solid concrete slab with anti-vibration pads between unit feet and concrete. However, the Large ZX condensing unit has also been designed for wall mounting on suitable brackets. Wall mounting brackets are not included. Another factor to consider in finding a good installation site is the direction of the prevailing wind. For example, if the air leaving the condenser faces the prevailing wind, the air flow through the condenser can be impeded, causing high condensing temperatures ultimately resulting in reducing unit life. A baffle is a remedy for this situation.

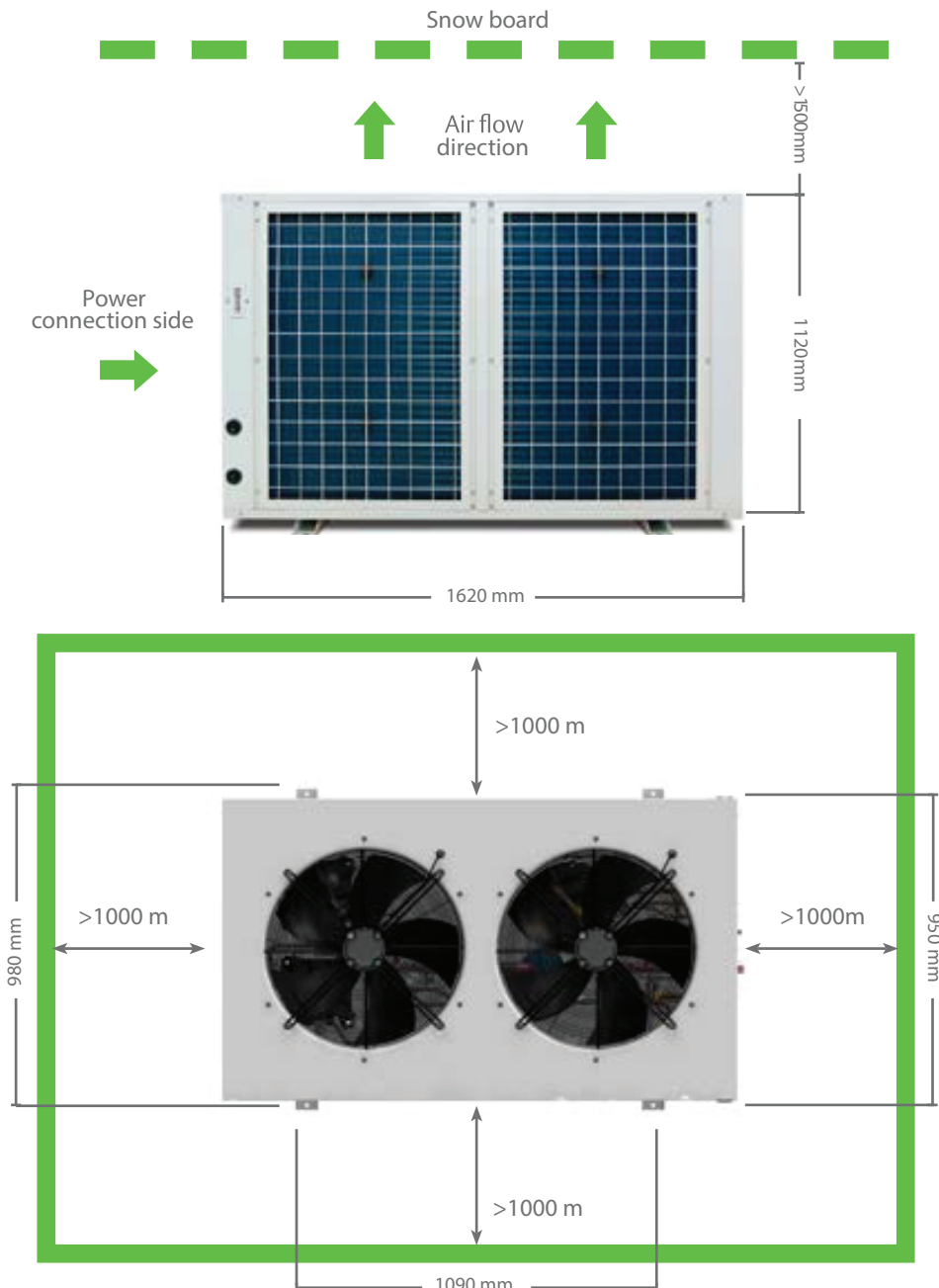

b. Refrigeration Piping Installation

All interconnecting pipes should be of refrigeration grade, clean, dehydrated and must remain capped at both ends until installation. Even during installation, if the system is left for any reasonable period (say two hours), pipes should be re-capped to prevent moisture and contaminants from entering the system.

Do not assume that the service connection sizes on the unit (at the service valves) are the correct size to run your interconnecting refrigeration pipes. The service valve sizes have been selected for convenience of installation and in some cases (larger units) these may be considered too small. However, for the very short pipe run within our units, these service connection sizes are adequate.

The pipe should be sized to ensure optimum performance and proper oil return. The sizing must also consider the full capacity range through which this particular unit will need to operate.

Pipe runs should be kept as short as possible, using the minimum number of directional changes. Use large radius bends and avoid trapping of oil and refrigerant. This is particularly important for the suction line. The suction line should ideally slope gently towards the unit. Recommendation slope is $1/200 \sim 1/250$. P traps, double risers and reduced pipe diameters may be required for suction lines where long vertical risers cannot be avoided. All pipes should be adequately supported to prevent sagging which can create oil traps.

The recommended pipe clamp support distance is shown in the table.

Tube Size	Max distance between 2 clamp supports
1/2 inch	1.2 M
5/8 inch	1.5 M
7/8 inch	1.85M
1 1/8inch	2.1 M
1 5/8inch	2.27 M

c. Refrigerant line insulation

- Insulate suction lines from the evaporators to the condensing unit with minimum 1” thickness closed-cell type insulation on low temperature circuits.
- Liquid lines of vapour injection to be minimum of 3/4” insulation.
- Suction and liquid lines should never be taped or soldered together.

d. Electrical

- a. All electrical work must be done in accordance with the National Electrical Code and existing local codes.
- b. Power supply must be the same as specified on the unit’s name plate.
- c. Voltage fluctuations in excess of 10 percent must be corrected.
- d. Before starting the unit, ensure that all protective devices are in place and that all wiring is secure.

b. Brazing Recommendation

Maintain a flow of oxygen-free nitrogen through the system at a very low pressure during brazing. Nitrogen displaces the air and prevents the formation of copper oxides in the system. If copper oxidization is allowed to form, the copper oxide material can later be swept through the system and block screens such as those protecting capillary tubes, thermal expansion valves, and accumulator oil return holes. This minimizes any entry of contaminants and moisture.

- Remove the liquid line connection cap.
- Then remove the suction connection cap.
- Open both valves midway.
- Care should be taken to avoid the holding charge from releasing too quickly.
- Be sure tube fitting inner diameter and tube outer diameter are clean prior to assembly.
- Since both tubes are extended from the condensing unit housing, we recommend insulating the housing by using a wet cloth on the copper tubing.
- Recommended brazing materials: a copper / phosphorous or copper / phosphorous / silver alloy rod should be used for joining copper to copper whereas to join dissimilar or ferric metals, use a silver alloy rod, either flux coated or with a separate.
- Use a double tip torch.

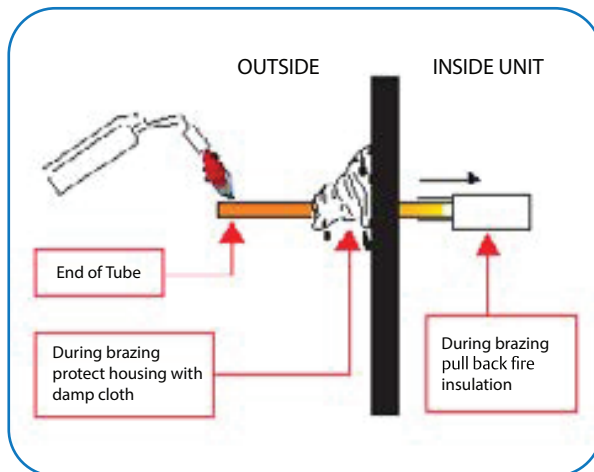

f. Expansion Valve Selection Consideration

As all the Large ZXD / ZXLD units are with vapour injection compressors, (except the 12HP MT), need to consider subcooled liquid temperature while selecting the expansion valve as given below.

Standard supply temperature °C

R404A

Evaporation temperature °C	Ambient temperature °C					
	20	27	32	38	43	48
-40	-8	-1	3	8	13	19
-35	-4	2	6	11	15	21
-30	0	6	9	13	18	23
-25	5	10	13	17	21	26
-20	9	14	17	20	24	30
-15	13	18	21	24	28	34
-10	18	23	27	32	36	-
-5	21	27	31	27	42	-

g. Start-up & Operation

Initial pressure test (by vacuum and nitrogen)

Step-by-step

- Use a 4-port gauge manifold with 3/8" hose and connections to the vacuum pump. The vacuum gauge does not have to be connected for this part of the process.
- Connect the gauges to service ports provided on receiver valve and suction tube. In order to remove any non-condensable that may have entered the system during installation, follow these steps:
- Start the vacuum pump. The evaporator fan should be running and the compressor crank case heater is energized at this point. This will involve powering up the unit so it is important to disconnect the live feed wire to the compressor contactor (so the compressor cannot run and the crankcase heater can be energized).
- Open both valves on the manifold and then open the main vacuum valve on the pump. Run the system until the vacuum level of -0.85 bar (as read on manifold gauge) is achieved.
- Shut off the main vacuum pump valve. Check for vacuum rise using the manifold compound gauge. A rise would indicate a large leak.
- If vacuum holds for 10 minutes, break vacuum with nitrogen and pressurize to 20 bar. Check for leaks and repair leakage.

Leak Check

The success of all the subsequent commissioning depends on a leak free system, free of contaminants, free of oxides, free of non-condensables, that has been evacuated to a low vacuum and charged with the prescribed refrigerant.

Leak test is particularly important for field-connected systems. Typically, field systems lose as much as 20%–30% of their refrigeration charge annually. This is not only an unnecessary expense but also damages the environment. Compressor oil can be lost at the same time as refrigerant and eventually lead to compressor failure. (Time spent on leak test will eventually reduce the time spent on the evacuation process).

Ensure that all service valves are open during the leak test process. It is important to recheck all joints within the unit as well as the external joints.

- a. The unit is shipped with a holding charge of dry nitrogen and should be leak free.
- b. Ensure that the test pressure do not exceed the system design pressures.
- c. Do not expose system pressure control LP to test pressures below the design pressure. This can damage the pressure controls.
- d. Using an approved, calibrated electronic gas leak detector, leak test the entire system paying attention to all joints.
- e. Periodically check functionality of the electronic leak detector during this process.
- f. To further check system integrity, spray a soapy water solution over joins then visually inspect for bubbles.
- g. Leave the system under pressure for a designated period (24 Hours).
- h. Check and record the ambient temperatures and the system pressure with calibrated approved instruments. This process is to be carried out every 8-12 hours during the pressure testing process.
- i. If the test pressures cannot be maintained, repeat the leak testing process employing the isolation of sections of the system to determine the source of leaks. Repair the leak and repeat the leak testing process until system can be signed off as leak free and approved by authorized personnel.
- j. Record findings and confirm pressure testing process completion.

Evacuation

- a. After the system is leak checked, connect approved dual stage vacuum pump sized to application with fresh oil to evacuation valve.
- b. Ensure all inline system shut-off valves and solenoid valves are fully open.
- c. Evacuate the system to 300 microns.
- d. In case of non-availability of micron gauge, a triple evacuation is recommended.

Charging and commissioning

REMINDER

- The scroll compressor design requires system charging with liquid refrigerant into the liquid line.
- Do not vapor charge the Large ZX Scroll unit. After ensuring all valves are opened and system is vacuumed properly, only then start the refrigerant charging process.

STEP-BY-STEP:

1. Ensure that there is no power supply to the Large ZX unit. The Liquid Line solenoid needs to be kept open for the charging process and this may require a temporary power feed to it.
2. Connect the refrigerant cylinder to main service hose and purge line at the manifold end.
3. Ensure correct orientation of the refrigerant cylinder. Follow cylinder labeling/instructions so that liquid refrigerant can be charged into the system. This will be charged through the high-pressure side of the manifold and Large ZX unit liquid service valve. Charge at least 70% of the required refrigerant in the system before starting the comp. Please do not bypass LP cutout during initial operation.
4. The compressor can then be started, and the unit continued to be charged (with controlled liquid refrigerant through the suction service valve). The quantity of charge should always be measured. See note.
5. The system needs to be operated down to its design evaporating temperature before you can be sure the charge is correct. It is at this point that the normal refrigeration operational checks can be carried out - such as checking the liquid line sight glass for violent bubbles and the operating pressures. Continue to charge about 1 kg after all the bubbles are gone in the liquid line sight glass. During this charging process the controller might show alarms E47 (EXV fully open) and E48 (injection shortage) which is to be ignored as unit is not completely charged. Refrigerant charging is regarded full/complete when the operating temperature of the system has been stable for some time and the liquid line sight glass is clear.

h. Additional Oil Charging in the System

Emerson Large ZX units are supplied with oil charge in the compressor as well as the oil separator / reservoir. However, depends on the length of interconnecting piping and the refrigerant charge in the system, there might be additional oil requirement. If the oil level in the oil reservoir goes below the lower sight glass after the system running for some time, customer needs to charge additional oil charge through suction line using manual oil pump and raise the oil level at least up to mid-level of the lower sight glass.

Refrigerant	Oil
R404A, R507, R448A, R449A, R407F	Emkarate RL 32 3MAF Mobil EAL Arctic 22 CC

i. Checks before starting and during running the system

- Check all the valves are fully opened
- Check the oil level of compressor and the reservoir after running the unit for some time.
- Check the discharge line temperature which is to be below 125°C.
- Suction and discharge pressures are within the operating envelope.
- The operating current is corresponding to the suction and discharge pressures.
- The compressor bottom shell is within the safe range as shown below

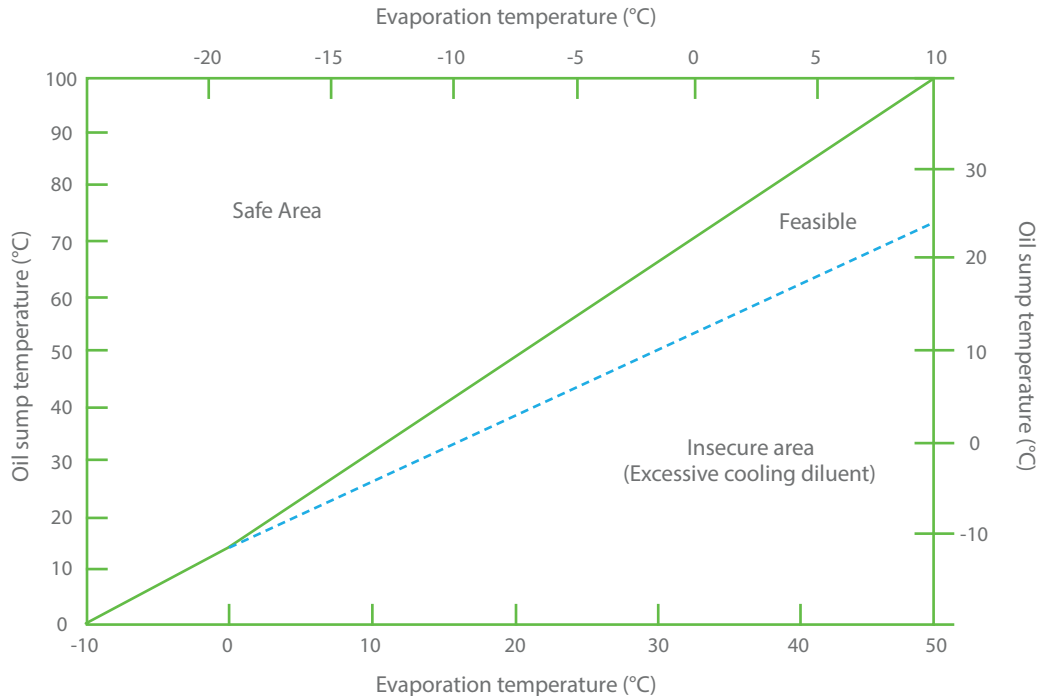

j. Maintenance

Condenser Fins

Condenser fins become dirty over time as ambient air is induced to the condenser. Dirty coil surfaces result in high condensing temperatures and poor unit performance. Regular cleaning is recommended with frequency depending on the installation and the surrounding environment. As a general guide, it is advisable to do this at least once every two months.

Fins should be cleaned with liquid detergent diluted with clean water. Before washing, a light brush downward (in the direction of the fins) should be done to remove heavy deposits.

Electrical Connections

Check tightness of electrical connections occasionally.

Routine Leak Test

All joints should be checked for leaks during site visits. All joints should be leak tested once a year. Condenser Fan(s) and Motor(s), an annual inspection of these items is recommended. Fastenings may loosen, bearings may wear, and fans may require cleaning of solid deposits which can cause imbalance.



TURN OFF OR DISCONNECT THE ELECTRICAL POWER SOURCE BEFORE CLEANING THE CONDENSER COIL OR DOING MAINTENANCE.

12. Troubleshooting

Alarm Codes

Level	Description
Warning	The unit (including the compressor) will keep running, but some status & data is already in an unsafe range; alarm dry-contact will not close; reset automatically
Alarm	The unit (including the compressor) may run not with full functions; alarm dry-contact will not close; reset automatically
Lock	The unit (including the compressor) stops working; alarm dry-contact will close; manual reset is needed

Code	Description	Possible Reasons	Action	Reset
E01	Suction pressure sensor failure alarm	Sensor failure or overrange	Digital compressor operates in preset mode	Reset automatically when the sensor is working
E02	Condensing pressure sensor failure alarm	Sensor failure or overrange	Function: fan speed control is disabled	Reset automatically when the sensor is working
E03	Digital compressor discharge line temperature sensor failure alarm	Sensor failure or overrange	Function: discharge temperature protection is disabled	Reset automatically when the sensor is working
E04	PHE vapor inlet temperature probe failure alarm	Sensor failure or overrange	Function: PHE superheat control is disabled	Reset automatically when the sensor is working
E05	PHE vapor outlet temperature probe failure alarm	Sensor failure or overrange	Function: PHE superheat control is disabled	Reset automatically when the sensor is working
E06	Ambient temperature probe failure alarm	Sensor failure or overrange	Related functional disabled	Reset automatically when the sensor is working
E07	Fixed-speed compressor discharge line temperature sensor failure alarm	Sensor failure or overrange	Fixed-speed compressor discharge line temperature protection function disabled	Reset automatically when the sensor is working
E09	1# current sensor fault alarm	Current overrange	Current protection function disabled	Reset automatically when the sensor is working
E10	2# current sensor fault alarm	Current overrange	Current protection function disabled	Reset automatically when the sensor is working
E11	1# voltage sensor fault alarm	Voltage overrange	Voltage protection disabled	Reset automatically when the sensor is working
E12	2# voltage sensor fault alarm	Voltage overrange	Voltage protection disabled	Reset automatically when the sensor is working
E13	3# voltage sensor fault alarm	Voltage overrange	Voltage protection disabled	Reset automatically when the sensor is working
E20	Missing phase alarm	One or two phases of the compressor power supply are missing or the voltage sensor is working abnormally	The compressor will be tripped	Automatically with time delay
L20	Missing phase lock	Missing phase alarm happened frequently	The compressor will be tripped and the unit will be locked	Press "Start" > 5 seconds or manually power cycle
L21	Wrong phase sequence lock	Compressor power supply has wrong sequence	The compressor will be tripped and the unit will be locked	Press "Start" > 5 seconds or manually power cycle

Code	Description	Possible Reasons	Action	Reset
E22	Three-phase imbalance warning	3-Ph voltages are not balanced	no	no
E23	Digital compressor over current alarm	Digital compressor current is larger than settings	The compressor will be tripped	Automatically with time delay
L23	Digital compressor over current lock	Digital compressor over current alarm happens frequently	The compressor will be tripped and the unit will be locked	Press "Start" > 5 seconds or manually power cycle
E26	Low voltage alarm	Voltage is lower than settings; or voltage sensors do not work	The compressor will be tripped	Automatically with time delay
L26	Low voltage lock	Low voltage alarm happens frequently	The compressor will be tripped and the unit will be locked	Press "Start" > 5 seconds or manually power cycle
E27	Over voltage alarm	Voltage is higher than settings	The compressor will be tripped	Automatically with time delay
L27	Over voltage lock	Over voltage alarm happens frequently	The compressor will be tripped and the unit will be locked	Press "Start" > 5 seconds or manually power cycle
E28	Digital compressor built-in protector opens alarm	Digital compressor built-in protector opens	The digital compressor will be tripped	Automatically with time delay
E31	Fix speed compressor over current alarm	Fix speed compressor current is larger than settings	The compressor will be tripped	Automatically with time delay
L31	Fixed speed compressor over current lock	Fix compressor over current alarm happens frequently	The compressor will be tripped and the unit will be locked	Press "Start" > 5 seconds or manually power cycle
E32	Fix speed compressor built-in protector opens alarm	Fixed speed compressor built-in protector opens	The digital compressor will be tripped	Automatically with time delay
E40	High pressure switch alarm	High pressure switch is open	The digital compressor will be tripped	Automatically when HP switch closes
L40	High pressure switch lock	High pressure switch alarm happens frequently	The compressor will be tripped and the unit will be locked	Press "Start" > 5 seconds or manually power cycle
E41	Low pressure switch alarm	Low pressure switch is open	The digital compressor will be tripped	Automatically when LP switch closes and time delay
E44	Digital compressor discharge line temperature overheating alarm	Digital compressor Discharge temperature is higher than settings	The digital compressor will be tripped	Automatically when discharge temperature is lower than settings and time delay
L44	Digital compressor discharge temperature overheating lock	Digital compressors high discharge temperature alarm happens frequently	The compressor will be tripped and the unit will be locked	Press "Start" > 5 seconds or manually power cycle
E45	High condensing pressure warning	Condensing pressure is higher than settings	no	Automatically when condensing pressure is lower than settings
E46	High condensing temperature warning	Condensing temperature is higher than settings	no	Automatically when condensing temperature is lower than settings
E47	EXV full-open warning	Less refrigerant charge or leakage	no	Automatically reset when the EXV is not fully open
E48	Less injection warning	Less refrigerant charge or leakage	no	Automatically when PHE super heat is smaller than settings

Code	Description	Possible Reasons	Action	Reset
E50	Liquid flood back warning	Low evaporator super heat or Too much liquid injection to the compressor	no	Automatically when the difference of discharge temperature and condensing temperature is higher than settings and time delay
E55	Fix speed compressor discharge line temperature overheating alarm	Fix speed compressor Discharge temperature is higher than settings	The digital compressor will be tripped	Automatically when discharge temperature is lower than settings and time delay
L55	Fix speed compressor discharge temperature overheating lock	Fix speed compressors high discharge temperature alarm happens frequently	The compressor will be tripped and the unit will be locked	Press "Start" > 5 seconds or manually power cycle
E56	Compressor oil shortage alarm	Compressor lack of oil	The digital compressor will be tripped	Automatically with time delay
L56	Compressor oil shortage lock	Compressor lack of oil alarm happens frequently	The compressor will be tripped and the unit will be locked	Press "Start" > 5 seconds or manually power cycle
E80	RTC warning	The time is configured for the new controller	no	Automatically when finish time configuration
E81	RTF warning	Communication error between MCU and unit clock	no	Automatically when the communication recovers
E82	Probe configuration error alarm	The same probes are configured	no	Automatically when the probes are configured correctly
E83	Digital inputs configuration error alarm	The same digital inputs are configured	Related functional failure	Automatically when the digital inputs are configured correctly
E84	Compressor configuration error alarm	Digital compressor and solenoid valve configuration does not match	The compressor will not work	Manually power off and power on after the compressor configuration is right
E85	Injection probe configuration error alarm	EXV and injection configuration dnot match	EXV will not work	Automatically when injection probe is configured correctly
L86	EEPROM read/write error lock	Write/read error into EEPROM	The compressor will tripped and the unit will be locked	Hold "start" button for 5s or manual power off and on, alarm will disappear when the communica - tion between MCU and EEPROM is success.



Digital compressor



Fixed-speed compressor

Fault phenomenon	Direct cause	Inspection analysis and adjustment
Before the following troubleshooting, first of all ensure the correctness, robustness and reliability of all wiring.		
<p style="text-align: center;">1 Compressor does not start</p> <p style="text-align: center;"></p> <p style="text-align: center;">Not bright / flashing, Compressor does not start</p> <p style="text-align: center;"></p> <p style="text-align: center;">Long bright, But the compressor does not start</p>	The controller did not receive a start signal	<p>Check whether the low pressure reaches the low pressure set point</p> <p>Check terminal No. 3 and NEUTRAL neutral line for 220VAC</p> <p>Check whether the wiring of terminal block No. 3 to controller input DI1 is reliable</p> <p>Normal shutdown will not start within 3 minutes, waiting time exceeds 3 minutes</p>
	Contactor failure or wiring failure	Check whether the contactor coil A1 has 220V AC. If there is 220VAC, check the virtual connection of the compressor terminal and the contactor coil terminal or replace the contactor; if no 220VAC, check if the controller C2 FireWire is connected properly
	Controller failure	Replace the controller
	Electricity failure	Need to confirm that the power supply voltage and waveform are normal
	The fuse is blown	Replace the fuse and monitor the current after restart
	Air switch trip	Need to confirm whether over current, whether leakage, grounding is normal, whether the air switch itself is faulty
	Contactor failure	Need to confirm whether the contact is stuck, whether the starting voltage is insufficient
	Unit control is in protection status (alarm code display)	Check whether it is a true protection action or a malfunction due to a fault code
	Power supply phase error (L21)	Refer to Article 14 [Phase of three phases] Related Content
	Power Phase Loss (E20 or L20)	Refer to Article 13 [Three-phase phase loss] Related content
	Three-phase voltage imbalance	Need to confirm whether there is a virtual connection of the power line, whether it is used in a phase of high-power single-phase electrical appliances
	Compressor Overcurrent (E23/L23: Digital Compressor, E31/L31: Constant Speed Compressor)	Refer to Article 15 [Overcurrent Errors] Related Content
	Exhaust pressure too high protection (E40 or L40)	Refer to Article 2[Exhaust Pressure High Protection] Related Content
	Inspiratory pressure too low protection (E41)	Refer to Sections 3, 4 [Insufflation Pressure Protection] Related Content
	Excessive exhaust temperature protection (E44/L44: digital compressor, E55/L55: fixed speed compressor)	Refer to Article 5 [Exhaust temperature protection is too high] Related content
	User-side temperature controller instruction shutdown	Need to confirm whether it has reached the temperature set point, whether it enters the defrost program, whether the thermostat is faulty
	Controller failure or transformer failure	Need to confirm the controller display is on replace the controller to see if the fault still exists
	Built-in compressor protection (E28: digital compressor, E32: fixed speed compressor)	Refer to Article 15 [Controller Output Run Command but No Compressor Current Detected]
	Power supply voltage is too low	A) Check whether the power supply voltage deviation meets the unit usage requirements
	Capacitor failure	A) Confirm that the capacitor wiring and specifications are correct (refer to the unit wiring diagram) B) Check if the capacitor is damaged

Fault phenomenon	Direct cause	Inspection analysis and adjustment
<p>2 Code "E40 or L40" Discharge pressure High protection or lock</p>	If the high pressure is high (high pressure protection value 30 kg):	
	Shutoff valve or other system valve forgot to open	One-by-one confirmation of system processes
	The ambient temperature is too high or the air intake channel is blocked	Improve ventilation and ensure that the return air temperature of the condenser is equal to the ambient temperature outside the building, ensure sufficient airflow space before and after the unit.
	Condensing fan is working abnormally	Reference No. 12 [Condensing fan does not operate, or operates abnormally]
	Dirty condenser surface	Sweep condenser
	Too much refrigerant	For non-azeotropic refrigerants, such as R404A, release some of the refrigerant from the stop valve of the liquid tube, and use slow release to prevent excessive loss of the lubricant.
	Air inside the system	There may be intermittent air bubbles in the sight glass. If it is confirmed that air is in system, need to remove air (re-vacuum and add refrigerant)
	Over-throttle	A) Check throttling device is normally open B) Choosing throttling device is too small
	High pressure switch failure	Short-circuit the two ends of the controller directly to connect the high pressure switch, and confirm whether the high pressure switch is damaged
	FireWire to C2 port is open all the way	If the "E40 or L40" is reported at the same time the fan is not working, please check: 1. If the two fuses next to the contactor are damaged; 2. Check the terminal block and the controller under the line wiring for loose or wrong connection
Controller failure	Controller shows error, replace controller	
<p>3 Code "E41" suction pressure Low protection (limited to medium temperature unit)</p>	Wrong controller	The controller for medium temperature unit ZXD and the low temperature unit ZXLD must be used in one-to-one correspondence.
	Low pressure switch and wiring fault	Ensure that the low pressure switch should be closed (turned on) when the low pressure is greater than 1 kg
<p>4 Suction pressure is too low</p>	Shutoff valves in the system does not open properly	Check the system valves one by one
	System lack of refrigerant	Need to confirm whether the charge is insufficient, whether the system leaks. If the system leaks, need to find leak point and handle properly
	Abnormal evaporator, heat exchanger is too small	Need to confirm whether the evaporator fan and the motor are abnormal, whether it is defrosting, defrosting is not clean, whether the drainage is not smooth, and whether the sundries obstruct the airflow passage.
	Expansion valve opening is too small	Whether the expansion valve is blocked or if the expansion valve is improperly adjusted. Whether temperature package leaks
	Filter plugging, suction pipe pressure drop too high	Need to confirm whether filter is dirty, if it is blocked by ice, if it needs to be replaced, replace the filter or replace the filter core
	Part selection deviation	Evaporator selection is too small, or the expansion valve selection is too small, or the unit selection is too large. Recheck the load and select the model. Whether medium temperature units are used for low temperature applications

Fault phenomenon	Direct cause	Inspection analysis and adjustment
<p>5</p> <p>Code "E44/L44" Digital compressor discharge gas overheating alarm or locked</p> <p>Code "E55/L55" Fixed speed compressor discharge gas overheating alarm or locked</p>	Low pressure during normal operation	Measure operating low pressure. Need to confirm whether the low pressure set in controller is correctly, whether the controller or low pressure switch is faulty. If there is a fault, replace the corresponding device. Also refer to [3. suction pressure Low protection] Related Content
	High pressure during normal operation	To measure the operating high pressure, make sure that the high pressure switch is working properly. If there is a fault, replace the corresponding device. Also refer to [2. Discharge pressure High protection Or lock]
	Suction superheat is too high	Need to confirm whether there is lack of refrigerant, whether the opening of the expansion valve is too small, whether insufficient insulation of the suction pipe
	Injection system failure	<p>A) The need to confirm whether the electronic expansion valve failure: coil damage, dirty or ice blocking.</p> <p>B) Need to confirm if the filter before the electronic expansion valve is blocked.</p> <p>C) It is necessary to confirm whether the inlet/ temperature sensor for PHE is faulty or missing. Refer to the sensor temperature-resistance characteristics table in this manual.</p> <p>D) It is necessary to confirm whether insufficient charging leads to gas-liquid two-phase in the liquid pipe, so that the injection circuit cannot take liquid properly.</p> <p>E) Need to confirm if the controller is faulty.</p>
	Refrigerant mixed with impurities, refrigerant composition changes	Re-evacuation and charge of qualified refrigerant
	System lacks of refrigerant	1, the sight glass should be full glass status. 2, the liquid pipe should have sufficient subcooling. Need to confirm whether the charge is insufficient, whether the system leaks. If leaks need to find leak point and handle properly
	Compressor failure	It is necessary to confirm whether the compressor current corresponds to operating high and low pressure. If not, the compressor may have worn
	Discharge temperature sensor and wiring fault (measured discharge temperature is less than 125 degrees)	Check if the sensor fails and check if the sensor falls out. Refer to the sensor temperature-resistance characteristics table in this manual
<p>6</p> <p>The system continues to have liquid, back Suction superheat less than 5K (such as frost o compressor body in medium temperature unit)</p>	Expansion valve opening too large	Need to confirm whether the expansion valve is oversized and whether it is excessive opening
	Abnormal evaporator, heat exchanger is too small	Need to confirm whether the evaporator fan and the motor are abnormal, whether it is defrosting, defrosting is not clean, whether the drainage is not smooth, and whether the sundries obstruct the airflow passage.
	Too much refrigerant	For non-azeotropic refrigerants, such as R404A, release some of the refrigerant from the stop valve of the liquid tube, and release slowly to prevent excessive loss of the lubricant.

Fault phenomenon	Direct cause	Inspection analysis and adjustment
7 Frequent compressors start up	If the compressor starts frequently during the defrosting process:	
	Operating suction pressure low due to low load	Need to confirm whether the unit selection is too large, the expansion valve selection is too small. Consider taking all indoor evaporator synchronization defrosting procedures
	Leakage of liquid line solenoid valve	Check if the low pressure rises during stop, replace the corresponding equipment (coil or valve body) when confirming the failure of the solenoid valve.
	Too much pressure drop in suction piping	Measure the pressure change at compressor suction and evaporator outlet during the shutdown process. It may be that the compressor suction pressure has decreased to the stop setting and the evaporator side liquid refrigerant has not completely evaporated. Need to improve piping design
	If the compressor is frequently started during normal operation:	
	The unit is at initial startup	It is normal phenomenon. At first time start after power on or over 1 hour shut off, the unit is in initial start procedure, during which the compressor will start up 3 times with 3 seconds running in each time, each time with 20 seconds interval.
	Frequent compressor protection (alarm code display)	Refer to [Compressor overcurrent], [Discharge pressure high pressure], [Suction pressure too low protection], [Discharge gas overheating] related content for detailed system check
	Thermostat failure	Check if the temperature difference between the start and stop of the thermostat is too small, and whether the thermostat fault frequently issues a stop command. If there is a fault, replace the corresponding device
	Controller failure	Try to replace the controller and see if the fault persists
Low pressure during normal operation	Measure operating low pressure. Need to confirm whether the low pressure set is correctly, whether the low pressure switch is faulty? If there is a fault, replace the corresponding device. Also refer to the relevant content of Article 3 [suction pressure Low protection]	

Fault phenomenon	Direct cause	Inspection analysis and adjustment
8 Abnormal noise	Compressor reverse running	Swap any two-phase wiring
	The compressor is overloaded	Check if the high-pressure pressure is running high, whether the low-pressure pressure is low, and whether the pressure ratio is too large.
	The compressor oil level is too low or too high	Confirm the oil level and perform oil drain or replenishment
	Too much refrigerant	Release some of the refrigerant from the stop valve liquid line slowly to prevent excessive loss of lubricating oil
	Continuous liquid back	Check if compressor oil tank temperature is low
	System with liquid start	Check whether the compressor crankcase heater is working during compressor stops and whether the liquid solenoid valve leaks.
	Compressor internal failure	Check if the compressor current corresponds to operating high and low pressure. If it is too high, it may indicate that the inside of the compressor may have worn
	Unit resonance	Try to press each pipe, bracket, housing, condenser, etc., and observe if the noise changes. After confirming the source of noise, reinforce, separate, or add sponge cushions to the corresponding parts.
	Unit contacts surrounding objects	Ensure that the space around the unit is clean and open, and that the unit body does not touch other objects (such as wires, sundries, etc.)
	Unit installation is loose	Re-confirm that the feet of the unit are firmly installed, no nuts in loose and no feet are impending
	Low condensing pressure	Low Ambient Kit (BOM-*81) should be selected in extremely low ambient areas, check if the fan speed control is normal
9 Cooling capacity cannot meet load demand	The unit is operating normally	Check if the unit operating is normal by checking if high pressure, low pressure, current, discharge temperature, return gas temperature, oil temperature are within a normal range. If yes, it is possible that the outdoor or indoor equipemnt selection is too small, and the system needs to be redesigned.
	Unit protection	Refer to above related content for detailed system check
	The compressor itself is working abnormally	Refer to section 1[Compressor does not start] for detailed system check]
	Flash gas before system expansion valve	The liquid line should be full of liquid before expansion valve (sight glass should be installed before the expansion valve)
	Liquid supply pipe insulation for units with PHE	The liquid supply pipe should be well insulated for units with PHE
	System lack of refrigerant	1, the sight glass should be full glass liquid 2, (for units with PHE) The liquid pipe should have sufficient subcooling, check whether the charge is insufficient and whether the system is leaking. If the system leaks, need to find leaking point and fix it
	Abnormal application status	Check the working status of the evaporator, check if the cooler's door is closed, check the goods temperature when putting into the cooler

Fault phenomenon	Direct cause	Inspection analysis and adjustment
10 Controller has no display	Circuit breaker cannot be turned on after closing	When the breaker is closed, the breaker has 380V input voltage and output voltage
	Natural wiring error	Any line-to-neutral voltage is 220VAC
	Broken fuse	Whether the two fuses next to the contactor are damaged
	Transformer damage	Measure whether the transformer input has 220V voltage and whether the output has 24V voltage. If the output is abnormal, replace the transformer.
11 Controller does not work	Controller code does not change or garbled	Power off and power on the unit, after re-start the controller, if the fault disappears, the fault can be ignored.
	Controller failure	If the fault continues, replace the controller
12 The condenser fan is not running, or in abnormal operation	Check if the fan blade is damaged	Check if the fan blade is damaged
	Check if fan motor malfunctions	Fan should be connected to fan capacitor and wired to 220VAC; check if fan motor failure or fan capacitor failure
	Check if the fan capacitor is damaged	Fan should be connected to fan capacitor and wired to 220VAC; check if fan motor failure or fan capacitor failure
	If above causes are excluded, replace the controller	Note: The condensing fan speed control is based on the condensing temperature collected, when condensing temperature sensor failures, will use ambient temperature sensor for speed control, if both sensors fail, the fan will be fully open. Refer to the sensor temperature-resistance characteristics table in this manual
13 Code "E20" or "L20" three-phase phase missing	Controller H25 parameter setting error	Check the label of the unit and check whether the parameters of the controller H25 are set correctly. The three-phase power is set to Yes and the single-phase is No. Please pay special attention to this after replacing the controller
14 Code "L21" three-phase phase Fault	The phase sequence of the unit incoming 3-ph lines is incorrect	Check the three-phase incoming line of the unit and exchange the two phases of the breaker input line.
	Controller three-phase error	Check whether the three-phase input of R, S, T in the lower left corner of the controller is consistent with the phase sequence on the terminal of the compressor (U, V, W). Take special attention when replacing a new controller.

Fault phenomenon	Direct cause	Inspection analysis and adjustment
<p>15 Code "E28" controller outputs digital compressor operation instructions, No current detected</p> <p>Code "E32" controller outputs fix speed compressor operation command, No current detected</p>	Built-in compressor protection	Measure the resistance between the terminals of the compressor to determine if the resistance is infinite and whether the three-phase resistance is balanced. After the compressor is fully cooled, try to start again. If normal operation can be performed again, please refer to [Compressor overcurrent], [Discharge pressure high protection], [Suction pressure low protection] and [Discharge gas overheating] to perform detailed system checks.
	Compressor motor burned	Measure the resistance between the terminals of the compressor. If it is confirmed that the compressor is faulty, replace the compressor. After restarting, you must refer to [Compressor overcurrent], [Discharge pressure high protection], [suction pressure low protection], [Discharge gas overheating] to perform detailed system checks.
	Compressor mechanical failure	Need to confirm whether the current is too high, whether the noise is high, with or without abnormal noise. If it is confirmed that the compressor is faulty, replace the compressor. After restarting, you must refer to [Compressor overcurrent], [Discharge pressure high protection], [suction pressure low protection], [Discharge gas overheating] to perform detailed system checks.
	Contactor and wiring fault	Check the three-phase voltage at the lower end of the contactor to determine whether there is loose or virtual connection, and replace the contactor.
	Controller failure	Replace the controller.
<p>16 Code "E23/L23" Digital Compressor Over current alarm or lock</p> <p>Code "E31/L31" Fix Speed Compressor Over current alarm or lock</p>	Controller current protection setting wrong	Check whether the controller H07/H09 (digital compressor) and H27/H28 (fix speed compressor) parameter values are consistent with the unit label. Especially when replacing a new controller, adjust the controller parameters to match the unit's labeling requirements.
	Contactor failure	Check the three-phase voltage at the lower end of the contactor to determine whether there is loose or virtual, resulting in excessive current due to missing phase.
	Internal damage to the compressor	Measure the actual operating current of the compressor, and determine whether the operating current is too high by referring to the high and low pressures.
<p>17 Code "E03"(digital compressor), "E07" (fix speed compressor) discharge line temperature sensor error</p>	Discharge line temperature sensor falls out or is not heat insulated well	Check if the temperature sensor is out or the heat insulation is not good
	The sensor itself fails	It is recommended to replace the temperature sensor directly
<p>18 Code "E01" Suction pressure transducer failure</p>	Actual suction pressure exceeds the transducer measuring range	Find out why the pressure is abnormal, like if there is no refrigerant in the system, or if the refrigerant is too much, so the pressure in the suction is too high.
	Pressure is normal, sensor connection or sensor itself fails	Check if the sensor wiring is normal and there is no blockage in the pressure tube where the sensor is located. Try replacing the sensor to see if it can eliminate the fault.

Fault phenomenon	Direct cause	Inspection analysis and adjustment
19 Code "L86" Controller internal memory EEPROM is abnormal	Controller internal memory is abnormal	Check whether the external device has remote communication with the controller, and whether there is any abnormality in the remote communication wiring and signal transmission. If the signal continues to be written into the controller, it will cause its memory to be damaged, and each writing requires a write completion instruction. Try to restart the controller if it can be solved. After the above troubleshooting, if the controller is still abnormal, replace the controller.

Temperature Sensor Resistance Table

Temperature (°C)	-30	-10	25	60	80	100	120
Discharge line temperature sensor resistance (Ω)	1522k	457k	86k	21k	11k	5.8k	3.4k
Condensing temperature, PHE vapor inlet and outlet temperature and ambient temperature sensor resistance (Ω)	111k	67.7k	42.5k	27.3k	17.9k	10k	5.82k

System Start-Up and Operational Check Sheet

Client Details

Facility/Customer Name :	
Address :	
Contact Details :	
Installer :	
Installation Date :	

Condensing Unit Info

CDU Model :	
Serial Number :	
CDU Location :	
Indoor Unit Make/Model :	

System Details

Room/Case ID :	
Pipe Length (approx.) :	
OAT @ Start-Up/Check :	
PSI Leak Test :	PSIG
Duration :	Hours
System is Leak Tight :	Y / N
Triple Evacuation :	Y / N
Micron Gauge Reading :	microns
Total Evacuation :	PSIG @ # of Hrs
Refrigerant :	
Total Charge :	Kg.
Sight Glass Clear :	Y / N
Evap Fans Running :	Y / N
Liquid Line Insulation :	Y / N
Sound and Vibration	

System Operation

COMP Voltage :	V
COMP Current :	A
Suction Pressure :	PSIG/Bar
Liquid Line Pressure :	PSIG/Bar
COMP Suction Temp :	°C
COMP Disch Temp :	°C
Liquid Line Temp :	°C
Compressor SH :	K
Subcooling :	K
Adjustable LP Setpoint :	PSIG
Design/Operating Temp:	°C
Actual Room/Case Temp :	°C
Condenser Fins :	

Comments

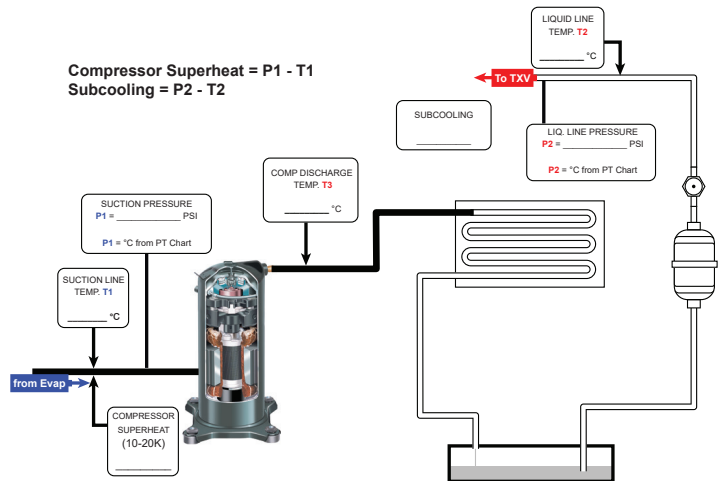

Prepared by: _____

Date: _____

Disclaimer

Technical data given was correct at the time of printing. Products, specifications and data in this literature are subject to change without prior notice. Updates will be done periodically. Should you need clarification of a specific data, value or information, kindly contact Emerson representative.

Contact list

United Arab Emirates

Jebel Ali Free Zone
P.O. Box 26382, Dubai
United Arab Emirates
Toll Free: 8000 441 3428
Tel: 971 4 8118100+
Fax: 971 4 8865465+

Saudi Arabia

P.O. Box 34332 - 3620
2nd Industrial City, 67 St.
Dammam, Saudi Arabia
Toll Free: 8008 443 426
Tel: 966 3 8147560+
Fax: 966 3 8147570+

South Africa

11 Quark Crescent
Linbro Business Park
Sandton 2065, South Africa
Toll Free: 0800 980 3711
Tel: 27 11 451 3700+
Fax: 27 11 451 3800+

Egypt

P.O.Box 11799
11 Mustafa Refaat Street
Sheraton, Heliopolis
Cairo, Egypt
Tel: 20 2 226 5854+



EmersonMEA



EmersonMiddleEastAfrica

EmersonClimateMEA.com



EMERSON™