

# Large ZX 22-30HP condensing unit



## ***Table of contents***

---

Introduction & disclaimer	<b>3</b>
Safety information	<b>4</b>
Nomenclature	<b>5</b>
Scope of supply	<b>5</b>
PI diagram	<b>6</b>
CDU models / data	<b>7</b>
Features & benefits	<b>9</b>
Physical layout	<b>10</b>
CoreSense controller	<b>12</b>
Networking	<b>18</b>
Electrical connections	<b>19</b>
Installation & start-up	<b>20</b>
Troubleshooting	<b>26</b>
Operational check sheet	<b>29</b>
About Copeland	<b>32</b>

Thank you for purchasing Copeland Simplex ZX Condensing Unit for refrigeration applications. This unit comes with high efficiency Copeland fixed capacity scroll compressor and liquid / vapor injection technology.

This is the best-in-class unit within the capacity and operating range available in the market.

Copeland ZX series has been highly successful in global market and has proven success with its energy savings and customer friendly electronic features.

This document is designed to help the contractor and customer for the installation, commissioning and operation of Copeland's Simplex ZX condensing unit.



## ***Disclaimer***

Please read through this operation manual to familiarize yourself with the installation, commissioning, and operation of this product. Please do read the following information in this page before proceeding with the rest of the manual.

The Copeland Simplex ZX scroll refrigeration condensing units should only be installed by suitably qualified and experienced refrigeration technicians. No responsibility can be accepted for damage caused by inexperienced or inadequately trained site technicians or improper system design. All instructions and procedures described in this manual are based on good refrigeration trade practices as applicable to this particular product. The installation contractor may prefer to use variations to these recommendations. However, the methods described in this manual represent the minimum requirements to avoid any subsequent warranty claims for this equipment and its components. These instructions do not cover the fundamentals of good electrical or refrigeration practice and are therefore intended for use only by qualified and/or experienced personnel or technicians.







For any additional query, please consult your local sales office, quoting unit model and serial number as shown on the nameplate. In case of ambiguity, the wiring diagram supplied with each unit takes precedence over the diagram in this manual.

## 1. Safety Information

**1.1** Installation and commissioning work on CDU shall be carried out only by qualified, refrigeration personnel who have been trained and instructed.

**1.2** Simplex ZX condensing unit is manufactured according to the latest safety standards. Emphasis has been placed on the user's safety. For relevant standards please refer to the manufacturer's declaration, available on request. You are strongly advised to follow these safety instructions.

### 1.3 Icon explanation

	<b>WARNING</b> This icon indicates instructions to avoid personal injury and material damage.
	<b>High Voltage</b> This icon indicates operations with a danger of electric shock
	<b>Danger of burning or frostbite</b> This icon indicates operations with a danger of burning or frostbite
	<b>Explosion hazard</b> This icon indicates operations with a danger of explosion
	<b>CAUTION</b> This icon indicates instructions to avoid property damage and possible personal injury
	<b>IMPORTANT</b> This icon indicates instructions to avoid malfunction of the compressor
<b>NOTE</b>	This word indicates a recommendation for easier operation





### 1.4 Safety Statements

- Only qualified and authorized refrigeration personnel are permitted to install, commission, and maintain this equipment.
- Electrical connections must be made by qualified electrical personnel.
- All valid standards for connecting electrical and refrigeration equipment must be observed.
- The national legislation and regulations regarding personnel protection must be observed.



Use personal safety equipment. Safety goggles, gloves, protective clothing, safety boots and hard hats should be worn where necessary.

## 1.5 General Instructions

	<b>Warning</b> <b>System breakdown! Personal injuries!</b> Never install a system in the field and leave it unattended when it has no charge, a holding charge, or with the service valves closed without electrically locking out the system.  Only approved refrigerants and refrigeration oils must be used.
	<b>Warning</b> <b>High shell temperature! Burning!</b> Do not touch the compressor until it has cooled down. Ensure that other materials in the area of the compressor do not get in touch with it. Lock and mark accessible sections.  Do not get contact with the compressor
	<b>Caution</b> <b>Overheating! Bearing damage!</b> Do not operate compressors without refrigerant charge or without being connected to the system.
	<b>Caution</b> Compressors contain oil and refrigerant under pressure. Release pressure from both high and low side of compressor before servicing.
	<b>Caution</b> Tube brazing and compressor operation can produce hot surfaces. To avoid burns, allow surfaces to cool.

### 1.6 Safety Refrigerants/Lubricant

- Please use correct refrigerant as designed to work in safe operating envelope.
- Compressor is supplied with an initial oil charge. The standard oil charge for use with HFC refrigerant is polyol ester (POE) lubricant Emkarate RL 32 3MAF.

### 1.7 Receiving your unit

All units are filled with an ideal gas at a positive pressure before transportation.

When you receive the unit from Copeland or an authorized representative, it is important to check the pressure of each unit. If the unit found to be without any pressure on receipt, please contact Copeland or their authorized distributor.

Damage to the unit caused by the transportation / handling should fall within the category of insurance claims and not be a manufacturing defect. It is also advisable to inspect the rest of the unit for any physical damage and inform Copeland or authorized distributor.

## 2. Nomenclature

<b>ZX</b>	<b>L</b>	<b>250</b>	<b>B</b>	<b>E</b>	<b>TFD</b>	<b>521</b>
Condensing Unit Family	L = Low Temp Blank = Medium Temp	22 to 30 HP	Generation	E = Ester Oil	TFD = 380V/420V 3Ph = 50Hz	522 = Without Door
<b>Base Model</b>					<b>Elect Code</b>	<b>BOM</b>

## 3. Standard Scope of Supply

521 BOM	ZX	ZXL
	521	521
Replaceable Core Liquid Line Filter Drier	✓	✓
Moisture Indicator	✓	✓
Liquid Line Isolation Valve	✓	✓
Oil Separator with Discharge Check Valve	✓	✓
Accumulator		✓
Adjustable HP / LP Switch	✓	✓
Fixed LP Safety Switch	✓	
HP Transducer	✓	✓
HP / LP pressure Gauge	✓	✓
Compressor Isolation Valves	✓	✓
Compressor Sound Jacket	✓	✓
Compressor Oil level Monitoring	✓	✓
Circuit breaker and contactor	✓	✓
Fan speed control 0 -10 V	✓	✓
CoreSense Protection	✓	✓
Intelligent store ready	✓	✓
Receiver certification (PED)	✓	✓
Receiver with Outlet Isolation Valve	✓	✓
Pressure Relief Valve	✓	✓

## 4. PI Diagram

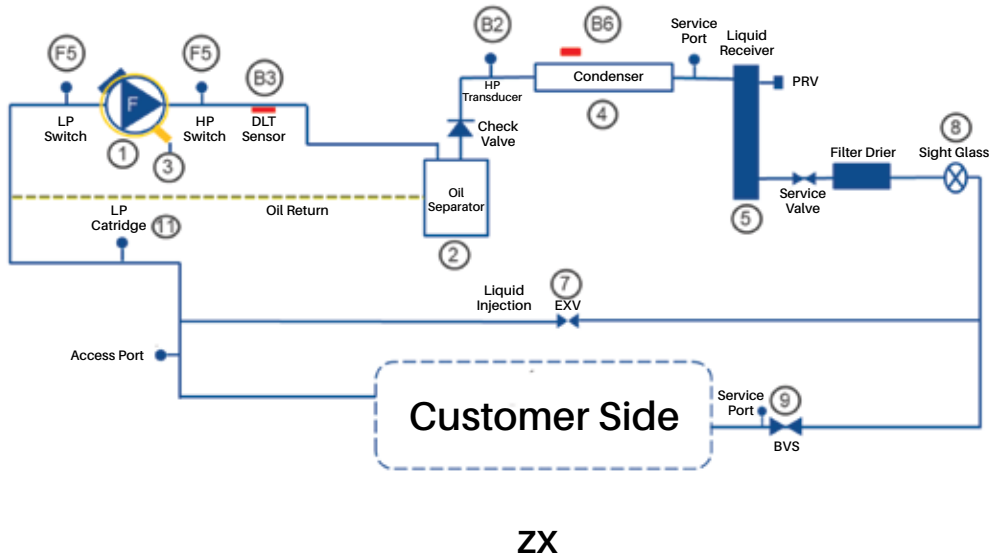

POS	Description
1	Compressor M1 with isolation valves
2	Oil separator
3	Crank case heater R2
4	Condenser
5	Receiver
6	...
7	Electronic expansion valve
8	Filter drier/Sight glass
9	Ball valve, Liquid line
10	...
11	Fixed LP cartridge switch
F5	Adjustable HP/LP dual pressure switch
B2	Pressure transmitter, HP
B3	Discharge line temperature sensor
B4	...
B5	...
B6	Ambient temperature sensor

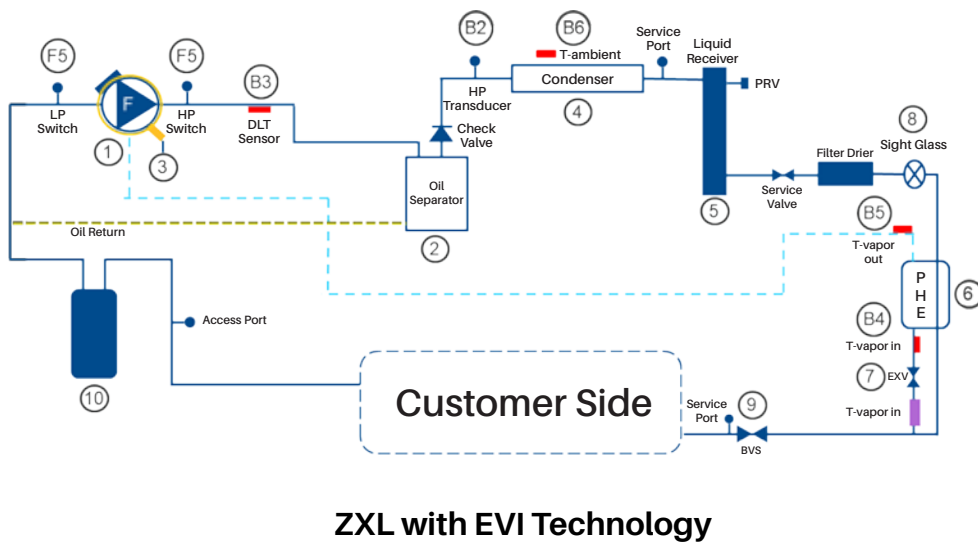

POS	Description
1	Compressor M1 with isolation valves
2	Oil separator
3	Crank case heater R2
4	Condenser
5	Receiver
6	Brazed plate economizer
7	Electronic expansion valve
8	Filter drier/Sight glass
9	Ball valve, Liquid line
10	Accumulator
F5	Adjustable HP/LP dual pressure switch
B2	Pressure transmitter, HP
B3	Discharge line temperature sensor
B4	Vapour in temperature sensor
B5	Vapour out temperature sensor
B6	Ambient temperature sensor

## 5. CDU Models/Data

POS	Ambient temperature (°C)	Capacity evaporating temperature (°C)						Power evaporating temperature (°C)					
		27.40	32.90	92.10	45.90	53.40	61.70	15.05	15.45	15.90	16.50	17.15	18.00
ZX220BE	27	27.40	32.90	92.10	45.90	53.40	61.70	15.05	15.45	15.90	16.50	17.15	18.00
	32	25.70	30.80	36.50	42.80	49.80	57.50	16.40	16.85	17.35	17.90	18.55	19.35
	38		28.10	33.30	39.00	45.40	52.40		18.70	19.25	19.85	20.50	21.20
	43			30.60	35.80	41.60	48.00			21.10	21.70	22.30	23.10
ZX250BE	27	33.50	40.10	47.30	55.40	64.10	73.50	18.95	19.55	20.30	21.10	22.00	23.20
	32	31.30	37.40	44.10	51.50	59.60	68.40	20.70	21.40	22.10	22.90	23.90	25.00
	38		34.10	40.10	46.80	54.10	62.00		23.80	24.70	25.50	26.50	27.60
	43				42.70	49.30	56.50				28.00	29.00	30.10
ZX300BE	27	41.20	49.20	58.10	67.90	78.60	90.00	22.80	23.60	24.40	25.40	26.60	28.00
	32	38.50	45.90	54.10	63.20	73.00	83.70	24.90	25.80	26.70	27.70	28.90	30.30
	38		51.90	49.20	57.30	66.20	75.80		28.70	29.70	30.80	32.00	33.40
	43				52.30	60.30	69.10				33.80	35.00	36.40

### Technical data

MT, 22 - 30 HP

TWM: 380~420V/3Ph/50Hz

Family				ZX		
Nominal rating		Horsepower	HP	22	25	30
Model name				ZX220BE	ZX250BE	ZX300BE
Performance	Sound Pressure Level	@1m	dB(A)	73	73	74
	Rated Load Ampere		Amp	31.4	41.4	57.9
Compressor	Locked Rotor Ampere		Amp	225	272	310
	Oil Type			POE		
	Oil Recharge Volume		Liters	4.38	6.51	6.00
	Qty		Pieces	2		
Fan Motor	Diameter		mm	710		
	Maximum Speed		rpm	1010		
	Air Flow	Total	m <sup>3</sup> /hr	29592	29592	25200
	Total Fan Motor Power	Input	W	2300	2300	2600
	Oil Separator	Volume	Liters	0.6		
Receiver Volume	R404a	kg	31.8			
Other	Pipes	Suction OD	Inch	1 5/8	2 1/8	
		Liquid OD	Inch	7/8	1 1/8	
	Dimension	W X D X H	mm	2013 x 872 x 2120		
	Weight	Nett	Kg	400	410	420
Gross		Kg	465	475	485	

## Performance table

LT 25 - 30 HP  
R404A

Model	Ambient temperature (°C)	Capacity evaporating temperature (°C)						Power evaporating temperature (°C)					
		-40	-35	-30	-25	-20	-15	-40	-35	-30	-25	-20	-15
ZXL250BE	27	18.25	21.80	26.30	31.60	37.80	44.90	13.60	14.40	15.20	16.15	17.20	18.40
	32	17.75	21.40	25.80	30.90	36.70	43.40	14.90	15.75	16.70	17.70	18.75	19.95
	38	16.80	20.70	25.00	29.90	35.30	41.40	16.70	17.70	18.75	19.80	20.90	22.20
	43		19.70	24.10	28.80	34.00	39.70		19.55	20.70	21.90	23.10	24.30
ZXL300BE	27	23.00	27.50	33.00	39.70	47.50	56.40	16.50	17.45	18.50	19.65	21.00	22.40
	32	22.30	27.00	32.50	38.80	46.10	54.40	18.05	19.15	20.30	21.50	22.90	24.40
	38	21.10	26.00	31.40	37.50	44.40	51.90	20.20	21.50	22.80	24.20	25.60	27.10
	43			30.20	36.20	42.70	49.70			25.20	26.70	28.20	29.80

## Technical data

LT, 10 - 20 HP  
TEM: 380~420V/3Ph/50Hz

Family				ZX	
Nominal rating		Horsepower	HP	22	30
Model name				ZX220BE	ZX300BE
<b>Performance</b>	Sound Pressure Level	@1m	dB(A)	75	75
<b>Compressor</b>	Rated Load Ampere		Amp	37.1	46.7
	Locked Rotor Ampere		Amp	246	310
	Oil Type			POE	
	Oil Recharge Volume		Liters	6.00	
<b>Fan Motor</b>	Qty		Pieces	2	
	Diameter		mm	710	
	Maximum Speed		rpm	1010	
	Air Flow	Total	m3/hr	29592	25200
	Total Fan Motor Power	Input	W	2300	2600
<b>Other</b>	Oil Separator	Volume	Liters	0.6	
	Receiver Volume	R404a	kg	31.8	
	Pipes	Suction OD	Inch	2 1/8	
		Liquid OD	Inch	7/8	
	Dimension	W X D X H	mm	2013 x 872 x 2120	
	Weight	Nett		Kg	440
Gross			Kg	505	520



## 6. Features and benefits

**Simplex ZX platform condensing units were designed based on demands by industry users:**

**Energy efficiency** - Utilizing Copeland scroll compressor technology, variable speed fan motor, large capacity condenser coil and advanced control algorithms, energy consumption is significantly reduced. End-users can save more than 20% on annual energy costs compared to equivalent reciprocating units.

**Reliability** - Combining the proven reliability of Copeland scroll compressors with advanced electronics controller and diagnostics, equipment reliability is greatly enhanced. Fault code alerts and fault code retrieval capabilities provide information to help improve speed and accuracy of system diagnostics. Integrated electronics provide protection against over-current, over-heating, incorrect phase rotation, compressor cycling, high pressure resets, low pressure cut-outs. It can also send out a warning message to an operator when there is liquid flood back, which can prevent critical damage on the unit.

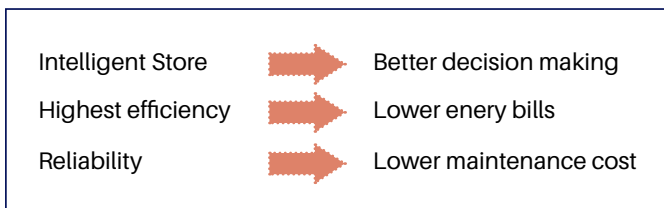

**Condensing unit features:**

- **Copeland scroll compressor technology**  
Highly efficient, ultra-quiet and highly reliable.
- **Configured with CoreSense controller**
  - Provides electronic diagnosis, protection, and communication modules for energy-saving and reliable unit control.
  - Analogue modulation for fans.
- **Enhanced vapor injection (ZXL only)**
  - Vapor injection provide high efficiency for refrigeration application
  - Well-tuned electronics algorithm with one big PHE for supplying sub-cooled liquid to the evaporator thus increasing the refrigeration effect and supplying cool gas into the compressor through the EVI port cooling the discharge of the compressor.

**Design features**

- ✓ Real-time monitoring of compressor operating conditions
- ✓ Compressor reverse rotation protection
- ✓ Compressor over current protection
- ✓ Compressor internal motor protector
- ✓ Discharge gas overheat protection
- ✓ Over voltage protection
- ✓ Under voltage protection
- ✓ High pressure protection
- ✓ Low pressure protection
- ✓ Refrigerant flood back warning
- ✓ Compressor minimum off time
- ✓ Compressor oil level protection
- ✓ Intelligent store solution: Communication and retail store monitoring

## 7. Physical layout of the unit

ZX: 22-30 HP MT

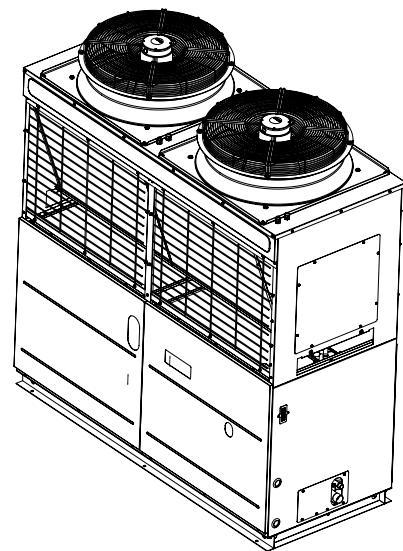
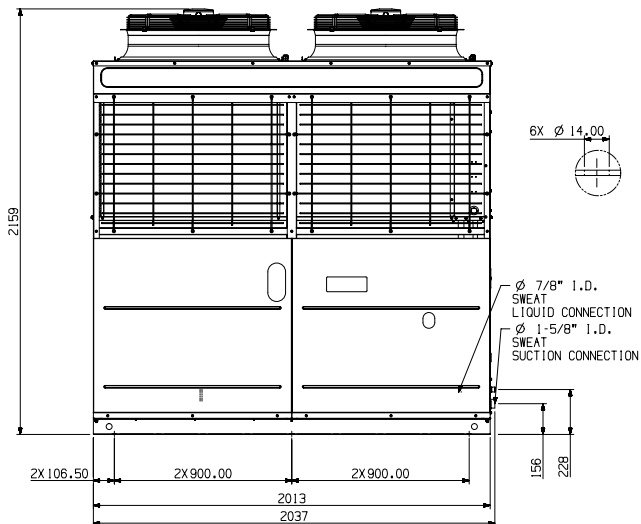
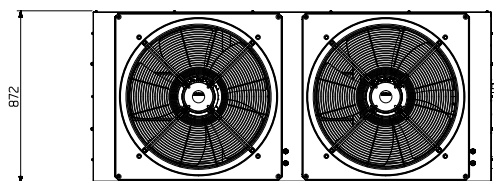
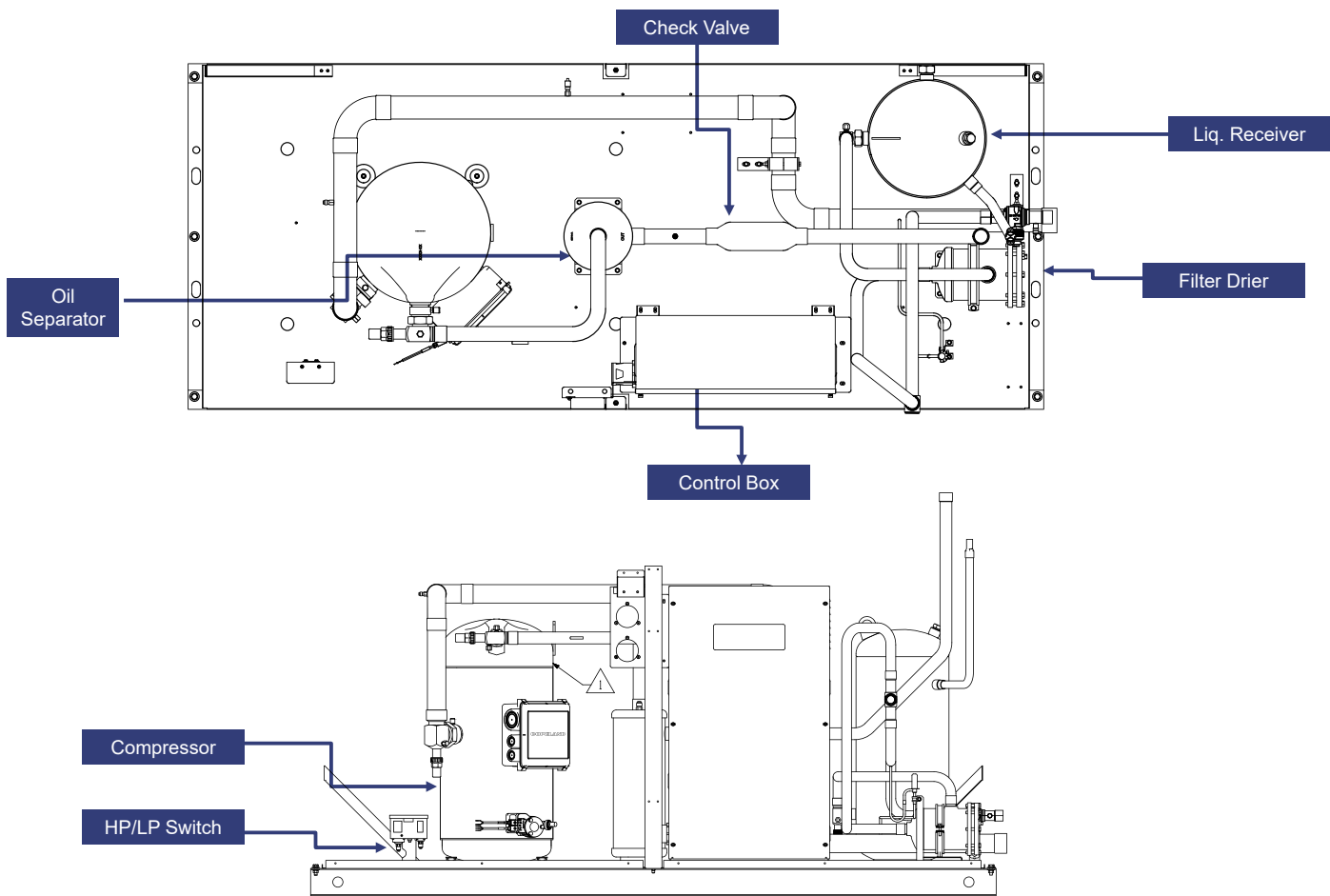

ZXL: 25-30 HP LT

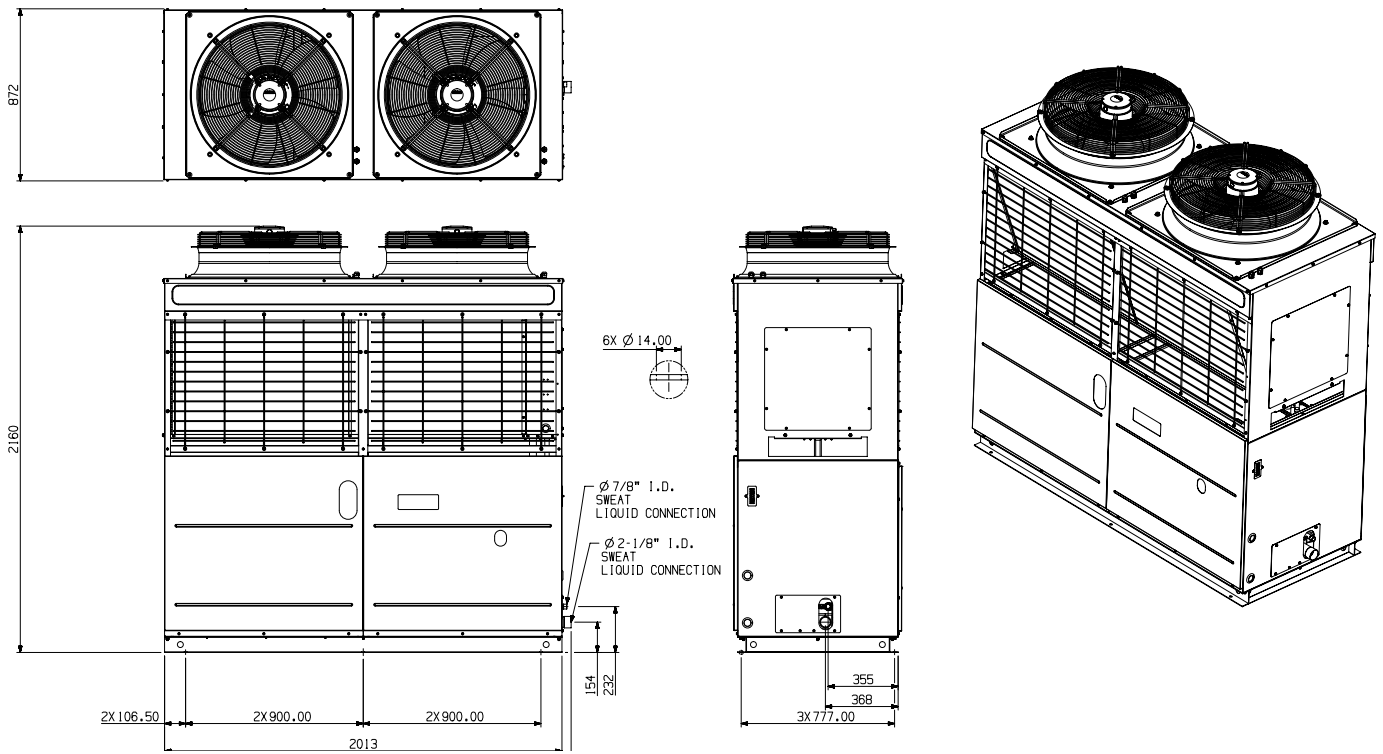
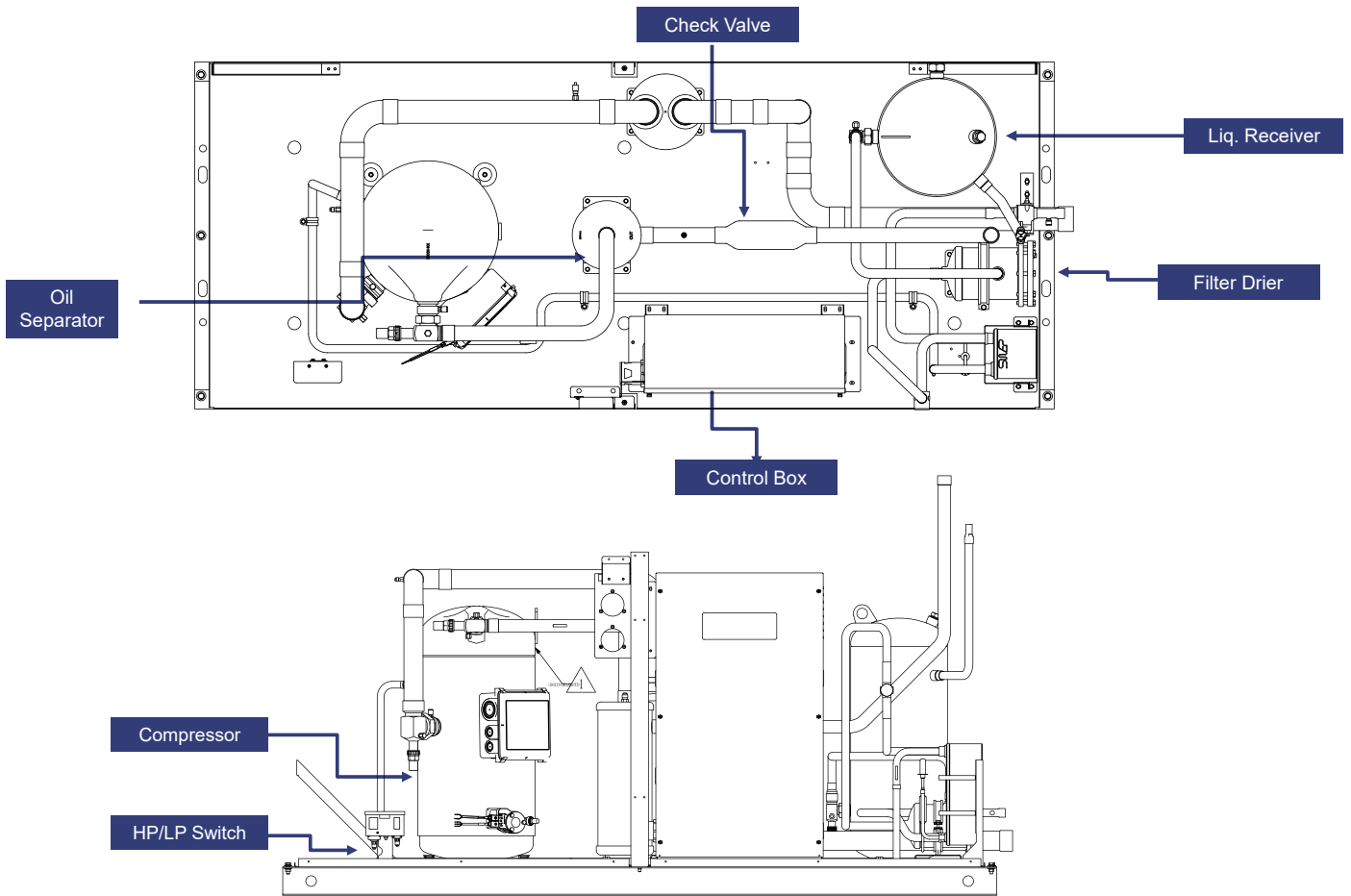

## 8. CoreSense controller

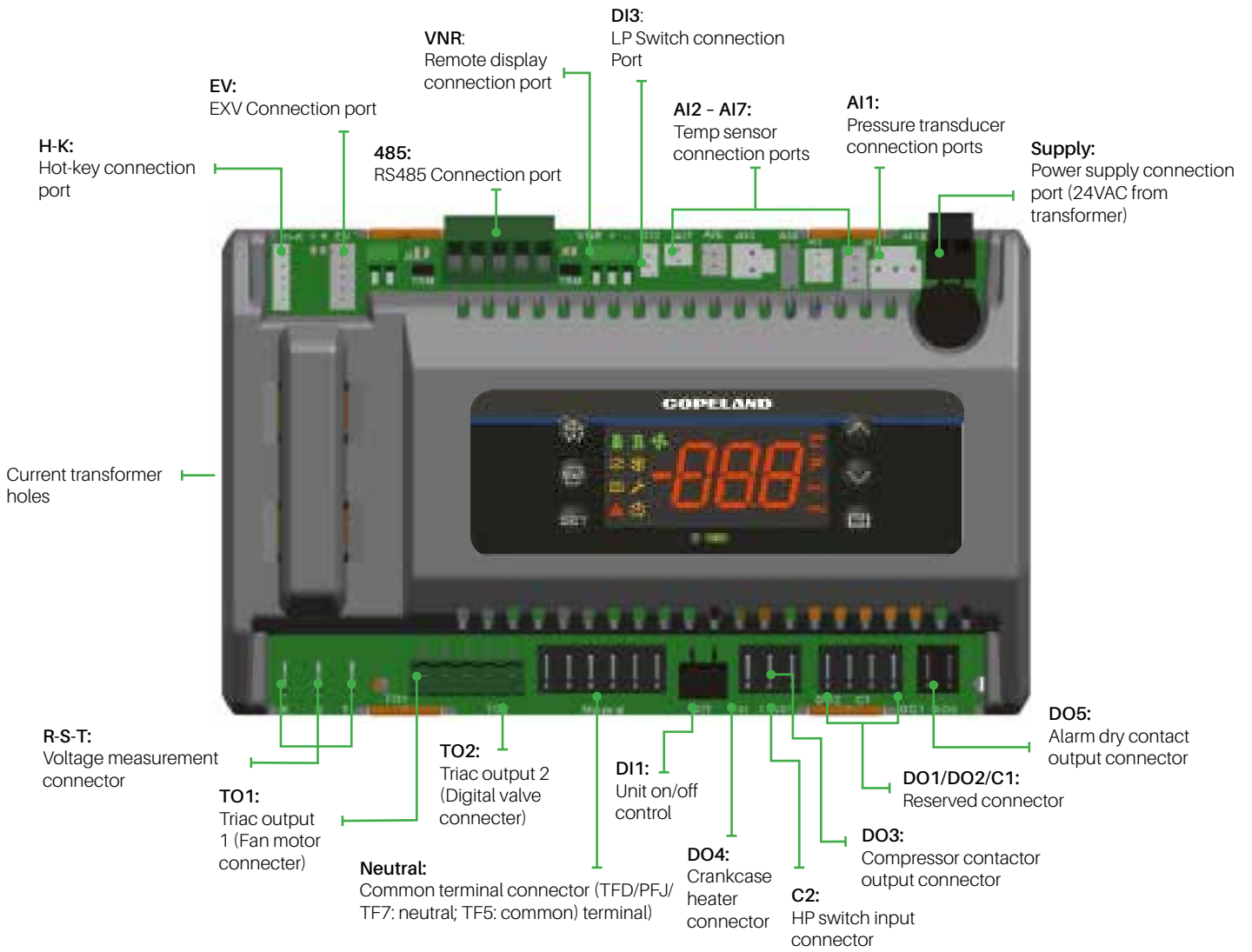



## LED descriptions

LED	Status	Description
	On	Compressor 1 is running
	Flashing	Compressor 1 is ready to start
	On	Compressor 2 is running
	Flashing	Compressor 2 is ready to start
	On	Condensing fan is running <sup>1</sup>
	On	Digital compressor is unloading
	On	Display with C
	Flashing	Programmable mode

LED	Status	Description
	On	Browsing the service menu
	Flashing	Browsing the fast access menu
	On	A new alarm happened
	Flashing	Browsing the alarm menu
	On	An alarm is occurring
	On	Liquid line solenoid valve on
	-	Reserved









## Keyboard descriptions - Single button

	Set	Displays target set point; In programming mode, select a parameter or confirm an operation.
	Reset	Hold for 5 seconds to reset any lockouts if the current state of the controller allow for it to be reset.
	Up	Enter the fast access menu; In programming mode, browse the parameter codes or increases the displayed value.
	Down	In programming mode it browses the parameter code or decreases the displayed value
	Service	Enter the service and alarm menu.
	Defrost	Hold for 3 seconds to start a manual defrost or terminate an active defrost (Not available at the moment).

## Keyboard descriptions - Combined buttons

		Press and hold for about 3 seconds to lock (Pon) or unlock (Pof) the keyboard.
		Pressed together to exit programming mode or menu; under rtC and PAr, this combination allows the user to go back to previous level.
		Pressed together for 3 seconds allows access to first level of programming mode.
		Pressed together for 3 seconds allows access to EXV manual setting.

## Refrigerants

Step	Action	Phenomenon and description
1	Press "SET" + 	Enter menu to select PAr (parameter) or rTC
2	Press  + 	Select PAr (parameter)
3	Press "SET"	Confirm selection
4	Press  or 	Browse to parameter C07
5	Press "SET"	Confirm selection
6	Press  or 	Select refrigerant to be used
7	Press "SET"	The number will flash for 3 seconds and confirm the refrigerant selection
8	Press  or 	Exit (or exit automatically after waiting for 120 seconds)









## Replacing controller

After a new controller is replaced and initial power is on, it is critical to reset parameters defined on the label below the nameplate on the unit panel. Here is an example of a label:



Controller Parameter Default Setting		
Model	Description	Default Value
Parameter		
H07	Digital compressor MCC	
H09	Digital compressor current protection	
H27	Fixed compressor MCC	
H28	Fixed compressor current protection	
H13	MIN. operating voltage	
H14	Max. operating voltage	
C07*	Refrigerant	

**Notes:** \*Ensure that parameters C07 is set to match the actual refrigerant used. If not, set C07 following label "Unit Operation Setting After Installation".





## Pr1 parameter (1st level) browse and modification

Step	Action	Phenomenon and description
1	Press " <b>SET</b> " + 	Enter menu to select PAr (parameter) or rTC
2	Press  or 	Select PAr (parameter)
3	Press " <b>SET</b> "	Confirm, select, and browse Pr1 parameters
4	Press  or 	Browse to Pr1 parameters
5	Press " <b>SET</b> "	View the actual number of the Pr1 parameters
6	Press  or 	Modify the actual number of the Pr1 parameters
7	Press " <b>SET</b> "	Press SET: the number will flash for 3 seconds and confirm the modifications; Will go to the next Pr1 parameter
8	Press " <b>SET</b> " + 	Exit (or exit automatically after waiting for 120 seconds)













## Quick access menu browse - Sensor status and actual values

Step	Action	Phenomenon and description	
1	Press 	Enter quick access menu, will display P1P (Press Up or Down to view other sensors)	
2	Press " <b>SET</b> "	View the actual value of P1P	
3	Press " <b>SET</b> "	Change to next sensor code	
4	Press " <b>SET</b> " + 	Exit (or exit automatically after waiting for 60 seconds)	
<p>Sensor code and values descriptions (nP, noP, or nA means that the sensor does not exist; Err means that the sensor fails, out of range, disconnected, or does not configure properly)</p>		P1P	Suction pressure sensor
		P2P	Condensing pressure sensor
		P3t	Digital compressor discharge line temperature sensor
		P4t	PHE vapor inlet temperature sensor
		P5t	PHE vapor outlet temperature sensor
		P6t	Ambient temperature sensor
		P7t	ON-OFF compressor discharge line temperature sensor
		5H	PHE superheat
		oPP	EXV opening percentage
		LL5	Solenoid valve status (not used)
		Std	Condensing temperature set point
		Aoo	Fan's analog output signal percentage
		dso	Percentage of PWM output driving the valve of the Digital Scroll compressor
		Lt	Minimum cold room temperature (unused)
		Ht	Maximum cold room temperature (unused)
		tU1	#1 voltage sensor
		tU2	#2 voltage sensor
		tU3	#3 voltage sensor
		tA`	#1 current sensor
		TA2	#2 current sensor
Hm	Time menu		

### Access alarm code (Maximum of 50 record)

Step	Action	Phenomenon and description
1	Press 	Display SEC
2	Press "SET"	Display A01
3	Press 	Display alarm code in A01
4	Press 	Display A02
5	Press 	Display alarm code in A02
6	...	...
7	Press "SET" + 	Exit (or exit automatically after waiting for 15 seconds)

### Exact timing of the alarm

Step	Action	Phenomenon and description
1	Press 	Display SEC
2	Press "SET"	Display A01
3	Press 	Display alarm code in A01
4	Press "SET"	Display Hr
5	Press 	Display the alarm exact timing: hour
6	Press 	Display Min
7	Press 	Display the alarm exact timing: minute
8	Press 	Display dAy
9	Press 	Display the alarm exact timing: day
10	Press 	Display Mon
11	Press 	Display the alarm exact timing: month
12	Press 	Display yEA
13	Press 	Display the alarm exact timing: year
14	Press "SET" + 	Exit (or exit automatically after waiting for 15 seconds)



### Upload the program from the controller to Hot-Key

Step	Action	Phenomenon and description
1	Insert Hot-key when the controller is on	
2	Press "  "	The uPL message will appear followed by a flashing End label (Note: If Err is displayed, it means it failed to upload the program to hot-key. Please restart the process.)
3	Press " <b>SET</b> "	End will stop flashing
4	Turn off the controller and remove the Hot-key	
5	Turn on the controller	

### Download the program from Hot-key to controller

Step	Action	Phenomenon and description
1	Turn off the controller	
2	Insert Hot-key	
3	Turn on the controller	The doL message will blink followed by a flashing End label (Note: If Err is displayed, it means it failed to download the program to Hot-key. Please restart the process.)
4		Controller will restart working with the new parameters after 10 seconds
5	Remove Hot-key	

# 9. Networking

## Dixell XWEBPRO Serial Address - Wiring

- Connect to the ModBUS network using cable with 2 or 3 shielded wires, minimum section 0.5mm<sup>2</sup> (e.g. BELDEN8772)
- Do not connect shield to ground.
- Do not connect the "Gnd" terminal.
- Remember to draw a map of the line. This will assist you in finding fault with communication issues.
- Please respect the polarity of RS485 devices.

## ZX CDU Connected to XWEB PRO

- ZX CDU connected to the Dixell XWEBPRO with the Intelligent Store Solution Module using RS485 ModBUS.
- Connect the ZX CDU to the ModBUS network as shown in Figure 5. Connect the network cable to the three-terminal connector on the XWEB port that has been configured as ModBUS port (COM 12, 13, 14).
- Connect port "13" of XWEBPRO to port "RS485 +" of CoreSense™ and port "12" of XWEB300D to port "RS485 -" of CoreSense™ for RS485 communication.

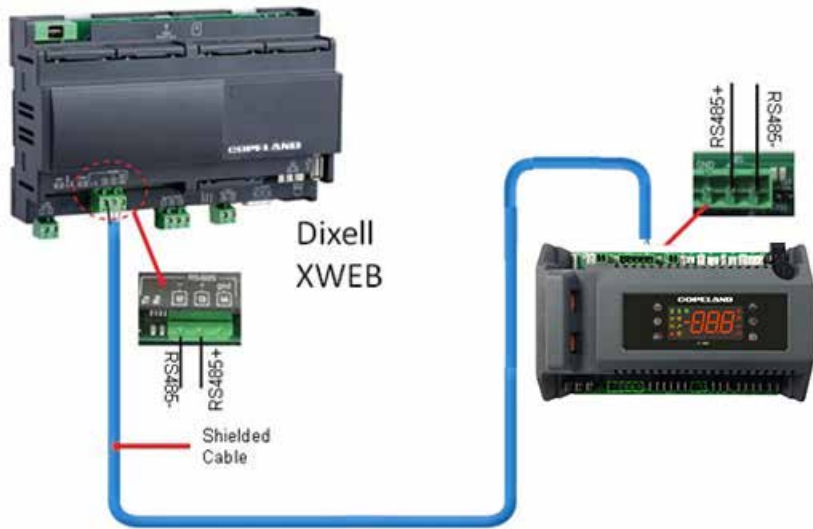

XWEB300D Connected to the Intelligent Store Solution Module



Correct Network Wiring

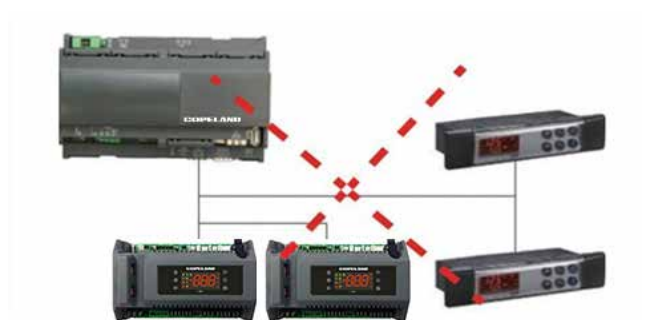

Incorrect Network Wiring

# 10. Electrical Connections

## ZX/ZXL-TWM/TEM Condensing Unit Electrical Wiring Diagram TWM/TEM : 380/420V, 50Hz, 3Ph + N

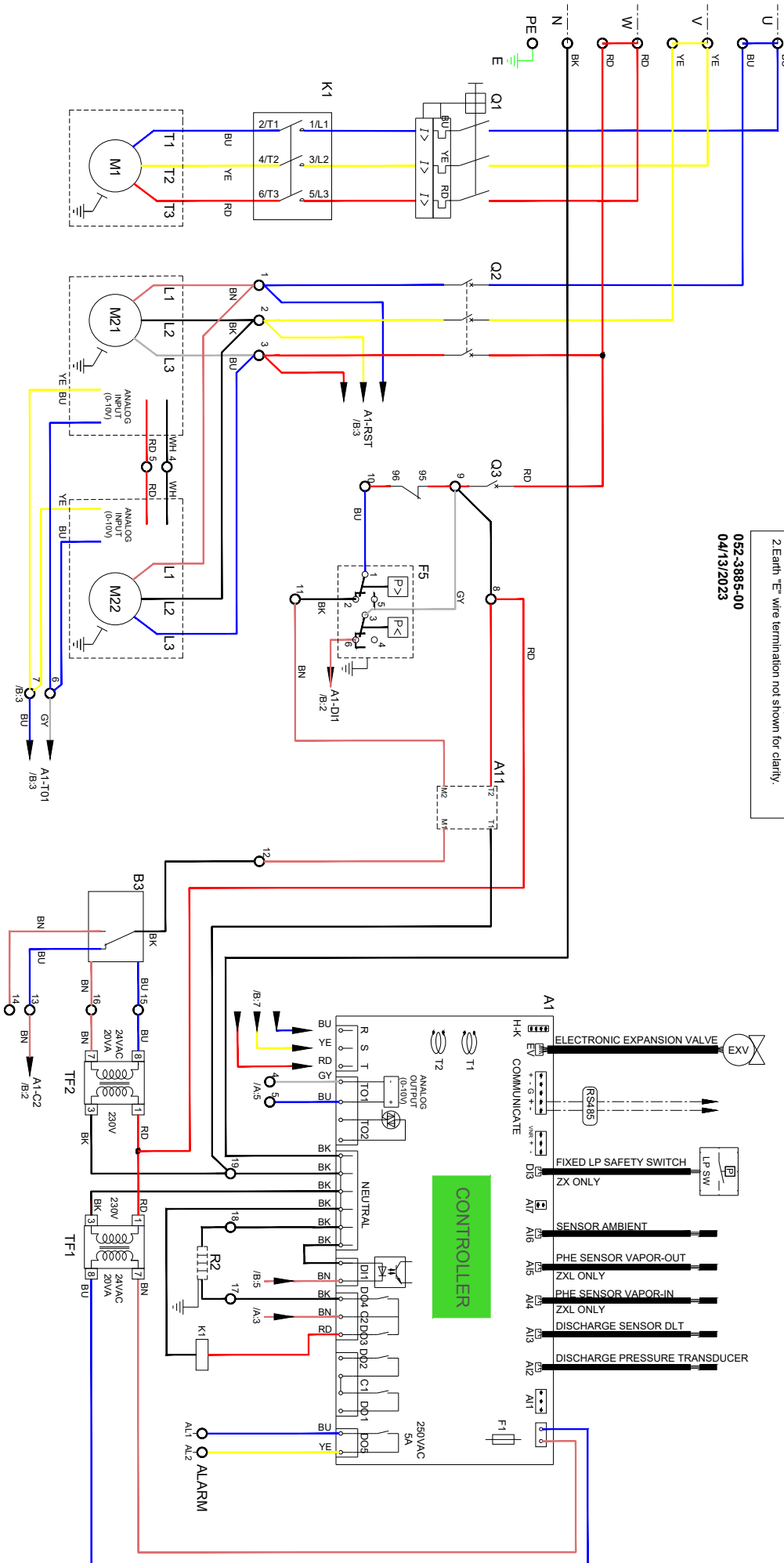

**NOTES:**  
 1.Dashed Line "-----" is wired by installer  
 2.Earth "E" wire termination not shown for clarity.

052-3885-00  
 04/13/2023

## 11. Installation, System processing and commissioning

Utmost care must be taken while handling the Simplex ZX condensing unit. Please go through the contents below to ensure proper handling.

### 11.1 Location and Fixing

Simplex ZX unit should always be installed in a location that ensures sufficient air flow. The minimum operating space for unit is described in below figure. Both service access and airflow have been considered in making these recommendations. Where multiple units are to be installed in the same location, the contractor needs to consider each individual case carefully. There can be many variations of unit quantities and available space and it is not the intention of this manual to go over these. Ideally, the unit should be mounted on a solid concrete slab with anti-vibration pads between unit feet and concrete. However, the Simplex ZX condensing unit has also been designed for wall mounting on suitable brackets. Wall mounting brackets are not included. Another factor to consider in finding a good installation site is the direction of the prevailing wind. For example, if the air leaving the condenser faces the prevailing wind, the air flow through the condenser can be impeded, causing high condensing temperatures ultimately resulting in reducing unit life. A baffle or deflector plate could be a remedy for this situation.

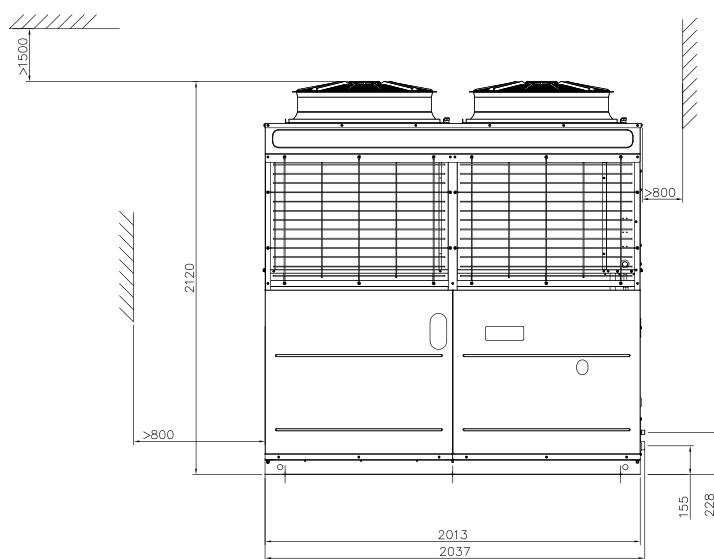

### 11.2 Location and Fixing

All interconnecting pipes should be of refrigeration grade, clean, dehydrated and must remain capped at both ends until installation. Even during installation, if the system is left for any reasonable period (say two hours), pipes should be re-capped to prevent moisture and contaminants from entering the system.

Do not assume that the service connection sizes on the unit (at the service valves) are the correct size to run your interconnecting refrigeration pipes. The service valve sizes have been selected for convenience of installation and in some cases (larger units) these may be considered too small. However, for the very short pipe run within our units, these service connection sizes are adequate.

The pipe should be sized to ensure optimum performance and proper oil return. The sizing must also consider the full capacity range through which this particular unit will need to operate.

Pipe runs should be kept as short as possible, using the minimum number of directional changes. Use large radius bends and avoid trapping of oil and refrigerant. This is particularly important for the suction line. The suction line should ideally slope gently towards the unit. Recommendation slope is 1/200~1/250. P traps, double risers and reduced pipe diameters may be required for suction lines where long vertical risers cannot be avoided. All pipes should be adequately supported to prevent sagging which can create oil traps.

The recommended pipe clamp support distance is shown in the table.

Tube Size	Max distance between 2 clamp supports
1/2 inch	1.20 m
5/8 inch	1.50 m
7/8 inch	1.85 m
1 1/8inch	2.10 m
1 5/8inch	2.27 m

### 11.3 Refrigerant line insulation

- Insulate suction lines from the evaporators to the condensing unit with minimum 1" thickness closed-cell type insulation on low temperature circuits.
- Liquid lines of vapour injection (ZXL unit) to be minimum of 3/4" insulation.
- Suction and liquid lines should never be taped or soldered together.

### 11.4 Electrical

- All electrical work must be done in accordance with the National Electrical Code and existing local codes.
- Power supply must be the same as specified on the unit's name plate.
- Voltage fluctuations in excess of 10 percent must be corrected.
- Before starting the unit, ensure that all protective devices are in place and that all wiring is secure.

### 11.5 Brazing Recommendation

Maintain a flow of oxygen-free nitrogen through the system at a very low pressure during brazing. Nitrogen displaces the air and prevents the formation of copper oxides in the system. If copper oxidization is allowed to form, the copper oxide material can later be swept through the system and block screens such as those protecting capillary tubes, thermal expansion valves, and accumulator oil return holes. This minimizes any entry of contaminants and moisture.

- Remove the liquid line connection cap.
- Then remove the suction connection cap.
- Open both valves midway.
- Care should be taken to avoid the holding charge from releasing too quickly.
- Be sure tube fitting inner diameter and tube outer diameter are clean prior to assembly.
- Since both tubes are extended from the condensing unit housing, we recommend insulating the housing by using a wet cloth on the copper tubing.
- Recommended brazing materials: a copper / phosphorous or copper / phosphorous / silver alloy rod should be used for joining copper to copper whereas to join dissimilar or ferrous metals, use a silver alloy rod, either flux coated or use additional flux.
- Use a double tip torch.

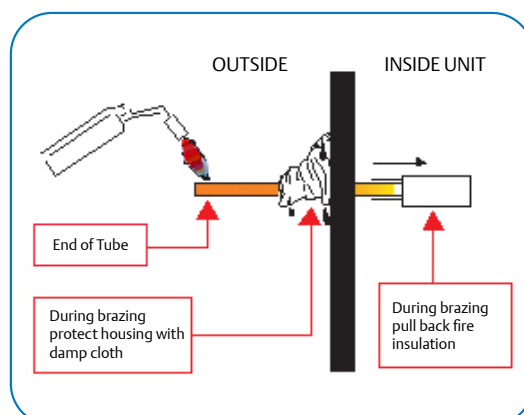

### 11.6 Expansion Valve Selection Consideration

As the Simplex ZXL units are with vapour injection compressors, (except the ZX units), need to consider subcooled liquid temperature while selecting the expansion valve as given below.

Standard supply temperature °C	R404A					
	Ambient temperature °C					
Evaporation temperature °C	20	27	32	38	43	48
-40	-8	-1	3	8	13	19
-35	-4	2	6	11	15	21
-30	0	6	9	13	18	23
-25	5	10	13	17	21	26
-20	9	14	17	20	24	30
-15	13	18	21	24	28	34

### 11.7 Start-up & Operation

#### Initial pressure test (by vacuum and nitrogen).

Step-by-step:

- Use a 4-port gauge manifold with 3/8" hose and connections to the vacuum pump. The vacuum gauge does not have to be connected for this part of the process.
- Connect the gauges to service ports provided on receiver valve and suction tube. In order to remove any non-condensable that may have entered the system during installation, follow these steps:
- Start the vacuum pump. The evaporator fan should be running, and the compressor crankcase heater is energized at this point. This will involve powering up the unit so it is important to disconnect the live feed wire to the compressor contactor (so the compressor cannot run, and the crankcase heater can be energized).
- Open both valves on the manifold and then open the main vacuum valve on the pump. Run the system until the vacuum level of -0.85 bar (as read on manifold gauge) is achieved.
- Shut off the main vacuum pump valve. Check for vacuum rise using the manifold compound gauge. A rise would indicate a large leak.
- If vacuum holds for 10 minutes, break vacuum with nitrogen and pressurize to 20 bar. Check for leaks and repair leakage.

#### Leak Check

The success of all the subsequent commissioning depends on a leak free system, free of contaminants, free of oxides, free of non-condensable's, that has been evacuated to a low vacuum and charged with the prescribed refrigerant.

Leak test is particularly important for field-connected systems. Typically, field systems lose as much as 20%–30% of their refrigeration charge annually. This is not only an unnecessary expense but also damages the environment. Compressor oil can be lost at the same time as refrigerant and eventually lead to compressor failure. (Time spent on leak test will eventually reduce the time spent on the evacuation process).

Ensure that all service valves are open during the leak test process. It is important to recheck all joints within the unit as well as the external joints.

- The unit is shipped with a holding charge of dry nitrogen and should be leak free.
- Ensure that the test pressure do not exceed the system design pressures.
- Do not expose system pressure control LP to test pressures below the design pressure. This can damage the pressure controls.
- Using an approved, calibrated electronic gas leak detector, leak test the entire system paying attention to all joints.

- Periodically check functionality of the electronic leak detector during this process.
- To further check system integrity, spray a soapy water solution over joints then visually inspect for bubbles.
- Leave the system under pressure for a designated period (24 Hours).
- Check and record the ambient temperatures and the system pressure with calibrated approved instruments. This process is to be carried out every 8-12 hours during the pressure testing process.
- If the test pressures cannot be maintained, repeat the leak testing process employing the isolation of sections of the system to determine the source of leaks. Repair the leak and repeat the leak testing process until system can be signed off as leak free and approved by authorized personnel.
- Record findings and confirm pressure testing process completion.

### **Evacuation**

- After the system is leak checked, connect approved dual stage vacuum pump sized to application with fresh oil in the vacuum pump.
- Ensure all inline system shut-off valves and solenoid valves are fully open.
- Evacuate the system to 300 microns.
- In case of non-availability of micron gauge, a triple evacuation is recommended.

### **Charging and commissioning reminders:**

- The scroll compressor design requires system charging with liquid refrigerant into the liquid line.
- Do not vapor charge the Simplex ZX Scroll unit. After ensuring all valves are opened and system is vacuumed properly, only then start the refrigerant charging process.

#### Step-by-step:

- a. Ensure that there is no power supply to the Simplex ZX unit. The Liquid Line solenoid needs to be kept open for the charging process and this may require a temporary power feed to it.
- b. Connect the refrigerant cylinder to main service hose and purge line at the manifold end.
- c. Ensure correct orientation of the refrigerant cylinder. Follow cylinder labeling/instructions so that liquid refrigerant can be charged into the system. This will be charged through the high-pressure side of the manifold and Simplex ZX unit liquid service valve. Charge at least 70% of the required refrigerant in the system before starting the comp. Please do not bypass LP cutout during initial operation.
- d. The compressor can then be started, and the unit continued to be charged (with controlled liquid refrigerant through the suction service valve). The quantity of charge should always be measured. See note.
- e. The system needs to be operated down to its design evaporating temperature before you can be sure the charge is correct. It is at this point that the normal refrigeration operational checks can be carried out - such as checking the liquid line sight glass for violent bubbles and the operating pressures. Continue to charge about 1 kg after all the bubbles are gone in the liquid line sight glass. During this charging process the controller might show alarms E47 (EXV fully open) and E48 (injection shortage) which is to be ignored as unit is not completely charged. Refrigerant charging is regarded full/complete when the operating temperature of the system has been stable for some time and the liquid line sight glass is clear.

### 11.8 Additional Oil Charing in the System

Copeland Simplex ZX units are supplied with oil charge in the compressor as well as the oil separator / reservoir. However, depends on the length of interconnecting piping and the refrigerant charge in the system, there might be additional oil requirement. If the oil level in the oil reservoir goes below the lower sight glass after the system running for some time, customer needs to charge additional oil charge through suction line using manual oil pump and raise the oil level at least up to mid-level of the lower sight glass.

#### Qualified refrigerant and oil

Refrigerant	Oil
R404A	Emkarate RL 32 3MAF Mobil EAL Arctic 22 CC

### 11.9 Additional Oil Charing in the System

- Check all the valved are fully opened
- Check the oil level of compressor and the reservoir after running the unit for some time.
- Check the discharge line temperature which is to be below 125 deg C.
- Suction and discharge pressures are within the operating envelope.
- The operating current is corresponding to the suction and discharge pressures.
- The compressor bottom shell is within the safe range as shown below

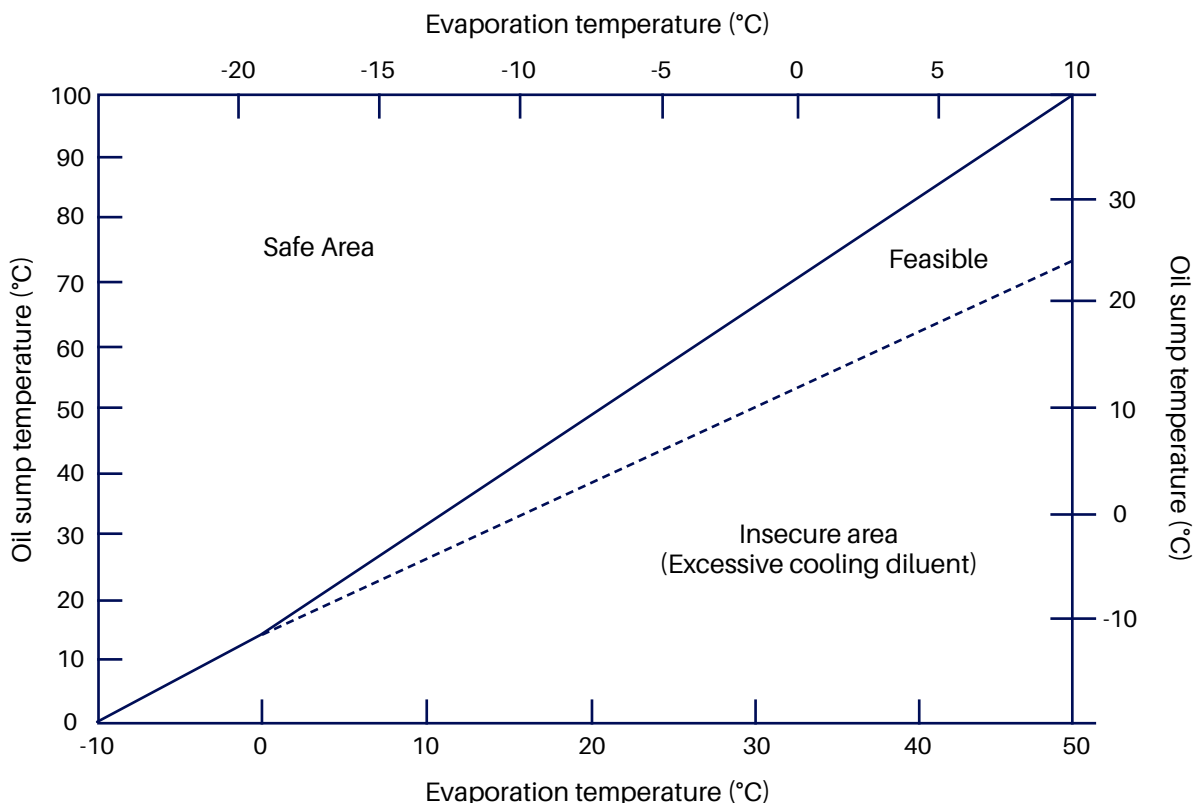



## 11.10 Maintenance

### Condenser Fins

Condenser fins become dirty over time as ambient air is induced to the condenser. Dirty coil surfaces result in high condensing temperatures and poor unit performance. Regular cleaning is recommended with frequency depending on the installation and the surrounding environment. As a general guide, it is advisable to do this at least once every two months.

Fins should be cleaned with liquid detergent diluted with clean water. Before washing, a light brush downward (in the direction of the fins) should be done to remove heavy deposits.

### Electrical Connections

Check tightness of electrical connections occasionally

### Routine Leak Test

All joints should be checked for leaks during site visits. All joints should be leak tested once a year. Condenser Fan(s) and Motor(s), an annual inspection of these items is recommended. Fastenings may loosen, bearings may wear, and fans may require cleaning of solid deposits which can cause imbalance.



**TURN OFF OR DISCONNECT THE ELECTRICAL POWER SOURCE BEFORE CLEANING THE CONDENSER COIL OR DOING MAINTENANCE.**

## 12. Troubleshooting

### Alarm codes

Level	Description
Warning	The unit (including the compressor) will keep running, but some status & data is already in an unsafe range; alarm dry-contact will not close; reset automatically
Alarm	The unit (including the compressor) may run not with full functions; alarm dry-contact will not close; reset automatically
Lock	The unit (including the compressor) stops working; alarm dry-contact will close; manual reset is needed

### Diagnostics

Alarm code	Description	Possible reason	Action	Reset
<b>Hardware error</b>				
E01	Suction pressure probe failure alarm	Probe failure or out of range	No (ZXD Unit Only)	Automatic Reset when the probe restarts working
E02	Condensing temperature probe failure alarm	Probe failure or out of range (-40 ~ 110°C)	Function: fan speed control is disabled	Automatic Reset when the probe restarts working
E03	Discharge temperature probe failure alarm	Probe failure or out of range (-40 ~ 180°C)	Function: discharge temperature protection is disabled	Automatic Reset when the probe restarts working
E04	PHE vapor inlet temperature probe failure alarm	Probe failure or out of range (-40 ~ 110°C)	Function: PHE Superheat Control is disabled (ZXL/ZXB unit only)	Automatic Reset when the probe restarts working
E05	PHE vapor outlet temperature probe failure alarm	Probe failure or out of range (-40 ~ 110°C)	Function: PHE Superheat Control is disabled (ZXL/ZXB unit only)	Automatic Reset when the probe restarts working
E06	Ambient temperature probe failure alarm	Probe failure or out of range (-40 ~ 110°C)	Related functions are disabled	Automatic Reset when the probe restarts working
E09	Current sensor 1 error alarm	Out of range	Related functions are disabled	Automatic Reset when the probe restarts working
E10	Current sensor 2 error alarm	Out of range	Related functions are disabled	Automatic Reset when the probe restarts working
E11	Voltage sensor 1 error alarm	Out of range	Related functions are disabled	Automatic Reset when the probe restarts working
E12	Voltage sensor 2 error alarm	Out of range	Related functions are disabled	Automatic Reset when the probe restarts working
E13	Voltage sensor 3 error alarm	Out of range	Related functions are disabled	Automatic Reset when the probe restarts working

Alarm code	Description	Possible reason	Action	Reset
<b>Electrical Error</b>				
<b>E20</b>	Missing phase alarm	One or two phases of compressor power supply lost or Voltage sensors do not work (3-ph unit only)	The compressor will be tripped	Automatically with time delay
<b>L20</b>	Missing phase lock	Missing phase alarm happened frequently	The compressor will be tripped and the unit will be locked	Press Start >5 sec or manually power-off and power-on
<b>L21</b>	Wrong phase sequence lock	Compressor power supply has wrong sequence (3-phase unit only)	The compressor will be tripped and the unit will be locked	Press Start >5 sec or manually power-off and power-on
<b>E22</b>	Imbalanced 3-phase warning	3-Ph currents are not balanced (3-phase unit only)	No	Automatically with time delay
<b>E23</b>	Over current alarm	Compressor current is larger than settings	The compressor will be tripped	Automatically with time delay
<b>L23</b>	Over current lock	Over current alarm happens frequently	The compressor will be tripped and the unit will be locked	Press Start >5 sec or manually power-off and power-on
<b>E24</b>	Compressor running circuit open alarm	Compressor running circuit open (1-phase unit only)	The compressor will be tripped	Automatically with time delay
<b>L24</b>	Compressor running circuit open lock	Running circuit open alarm happens frequently	The compressor will be tripped and the unit will be locked	Press Start >5 sec or manually power-off and power-on
<b>E25</b>	Compressor starting circuit open alarm	Compressor starting circuit open (1-phase unit only)	The compressor will be tripped	Automatically with time delay
<b>L25</b>	Compressor starting circuit open lock	Compressor starting circuit open alarm happens frequently	The compressor will be tripped and the unit will be locked	Press Start >5 sec or manually power-off and power-on
<b>E26</b>	Low voltage alarm	Voltage is lower than settings; or voltage sensors do not work	The compressor will be tripped	Automatically with time delay
<b>L26</b>	Low voltage lock	Low voltage alarm happens frequently	The compressor will be tripped and the unit will be locked	Press Start >5 sec or manually power-off and power-on
<b>E27</b>	Over voltage alarm	Voltage is higher than settings	The compressor will be tripped	Automatically with time delay
<b>L27</b>	Over voltage lock	Over voltage alarm happens frequently	The compressor will be tripped and the unit will be locked	Press Start >5 sec or manually power-off and power-on
<b>E28</b>	Compressor internal protector open warning	Compress internal protector is open; or current sensors do not work	No	The compressor will be tripped
<b>E30</b>	No controller power supply alarm	Controller lost power supply		

Alarm code	Description	Possible reason	Action	Reset
<b>Refrigeration system error</b>				
E40	High pressure switch alarm	High pressure switch is open	The compressor will be tripped	Automatically when HP switch closes
L40	High pressure switch lock	High pressure switch alarm happens frequently	The compressor will be tripped and the unit will be locked	Press Start >5 sec or manually power-off and power-on
E41	Low pressure switch alarm	Low pressure switch is open	The compressor will be tripped	Automatically when LP switch closes and time delay
E44	High discharge temperature alarm	Discharge temperature is higher than settings	The compressor will be tripped	Automatically when discharge temperature is lower than settings and time delay
L44	Higher discharge temperature lock	High discharge temperature alarm happens frequently	The compressor will be tripped and the unit will be locked	Press Start >5 sec or manually power-off and power-on
E46	High condensing temperature alarm	Condensing temperature is higher than settings	No	Automatically when condensing temperature is lower than settings
E47	EXV Full-open warning	Less refrigerant charge or leakage	No	Automatically when EXV is not at full-open
E48	Less injection warning	Less refrigerant charge or leakage	No	Automatically when PHE super heat is smaller than settings
E50	High side liquid back warning	Suction liquid back or injection too much	No	Automatically when the difference of discharge temperature and condensing temperature is higher than settings and time delay
E56	Compressor oil shortage alarm	Compressor lack of oil	The digital compressor will be tripped	Automatically with time delay
L56	Compressor oil shortage lock	Compressor lack of oil alarm happens frequently	The compressor will be tripped and the unit will be locked	Press "Start" > 5 seconds or manually power cycle

<b>Misc. Error</b>				
E80	RTC warning	The time is configured for the new controller	No	Automatically when finish time configuration
E81	RTF warning	Communication error between MCU and unit clock	No	Automatically when the communication recovers
E82	Probe configuration error alarm	The same probes are configured	No	Automatically when the probes are configured correctly
E83	Digital inputs configuration error alarm	The same digital inputs are configured	The related functions will be disabled	Automatically when the digital inputs are configured correctly
E84	Compressor configuration error alarm	Digital compressor and solenoid valve configuration does not match	The compressor will not work	Manually power off and power on after the compressor configuration is right
E85	Injection probe configuration error alarm	EXV and injection configuration do not match	EXV will not work	Automatically when injection probe is configured correctly
L86	EEPROM R/W error lock	write/read error into EEPROM	The compressor will tripped and the unit will be locked	Hold "start" button for 5s or manual power off and on, alarm will disappear when the communication between MCU and EEPROM is success.

### 13. System Start-Up and Operational Check Sheet

Client Details	
Facility/Customer Name:	
Address:	
Contact Details:	
Installer:	
Installation Date:	

Condensing Unit Info:	
CDU Model:	
Serial Number:	
CDU Location:	
Indoor Unit Make/Model:	

System Details	
Room/Case ID :	
Pipe Length (approx.) :	
OAT @ Start-Up/Check :	
PSI Leak Test :	PSIG
Duration :	Hours
System is Leak Tight :	Y / N
Triple Evacuation :	Y / N
Micron Gauge Reading:	microns
Total Evacuation :	PSIG @ # of Hrs
Refrigerant :	
Total Charge :	Kg.
Sight Glass Clear :	Y / N
Evap. Fans Running :	Y / N
Liquid Line Insulation :	Y / N
Sound and Vibration :	

System Operation	
COMP Voltage :	V
COMP Current :	A
Standing Pressure	PSIG/Bar
Suction Pressure :	PSIG/Bar
Liquid Line Pressure :	PSIG/Bar
COMP Suction Temp :	°C
COMP Disch. Temp :	°C
Liquid Line Temp :	°C
Compressor SH :	K
Subcooling :	K
Adjustable LP Setpoint :	PSIG
Design/Operating Temp:	°C
Actual Room/Case Temp :	°C
Condenser Fins :	

Comments

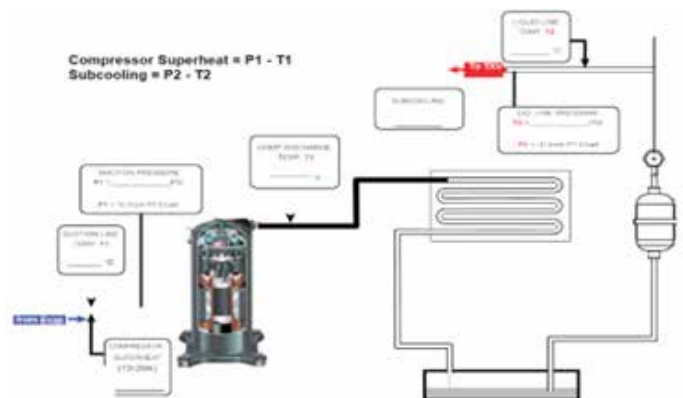

Prepared by:  
Date:

Confirmed by:  
Date:



## **Contact us:**

### **United Arab Emirates**

Jebel Ali Free Zone  
P.O. Box 26382,  
Dubai United Arab Emirates  
Toll Free: 8000 441 3428  
Tel: +971 4 8118100  
Fax: +971 4 8865465

### **Saudi Arabia**

P.O. Box 34332 - 3620  
2nd Industrial City, 67 St. Dammam,  
Saudi Arabia Toll Free: 8008 443 426  
Tel: +966 3 8147560  
Fax: +966 3 8147570

### **South Africa**

Workshop 17 Fire station  
16 Baker Street Rosebank  
Gauteng, South Africa, 2196  
South Africa Toll Free: 0800 980 3711  
Tel: +27 10 599 0301

### **Egypt**

P.O. Box 11799  
11 Mustafa Refaat Street Sheraton,  
Heliopolis Cairo, Egypt  
Tel: +20 2 226 5854



## *About Copeland*

Copeland, a global provider of sustainable climate solutions, combines category-leading brands in compression, controls, software and monitoring for heating, cooling and refrigeration. With best-in-class engineering and design and the broadest portfolio of modulated solutions, we're not just setting the standard for compressor leadership; we're pioneering its evolution. Combining our technology with our smart energy management solutions, we can regulate, track and optimize conditions to help protect temperature-sensitive goods over land and sea, while delivering comfort in any space. Through energy-efficient products, regulation-ready solutions and expertise, we're revolutionizing the next generation of climate technology for the better.

Scan to visit:



Copeland

To learn more, visit [copeland.com](https://www.copeland.com)

©2024 Copeland LP. All rights reserved.

**COPELAND**